

SUPER OFFERTA
EDIZIONE 1 - 2020



NUOVO KIT PLANNER ONLINE

€ Senza IVA - 60/2020 - VALIDA FINO AL 31/01/2021

KIT PLANNER ONLINE

CONFIGURATORE DI ASSORTIMENTI



Carrelli



Cassette



Kit
assortiti

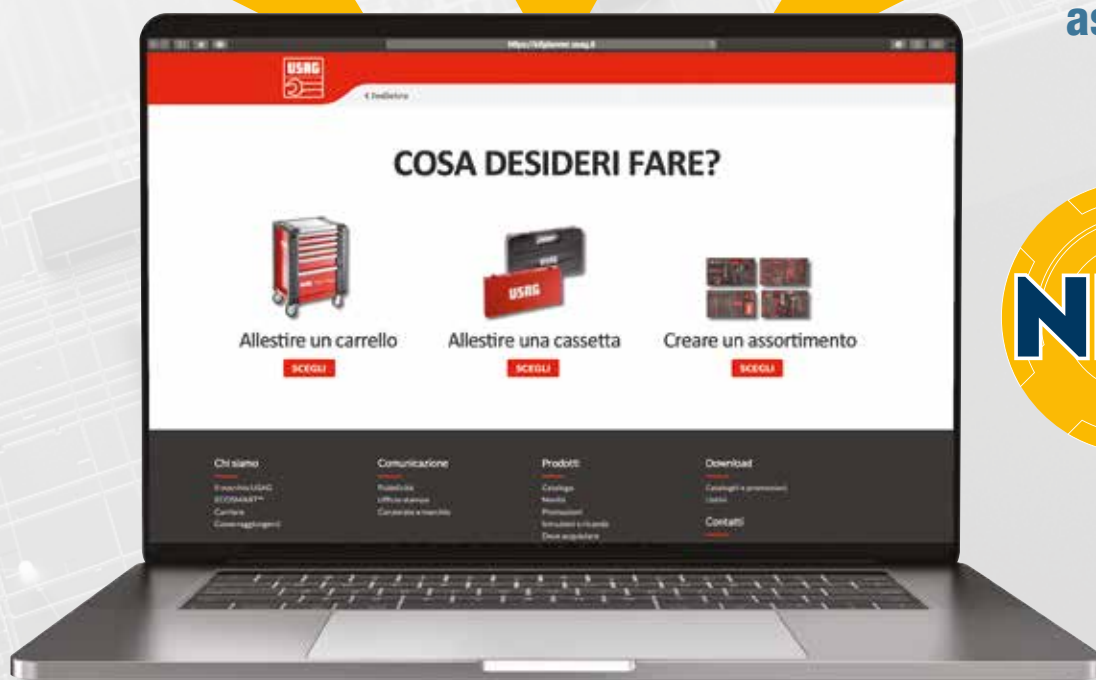

Il nuovo **KIT PLANNER** è il configuratore che ti aiuta a realizzare in modo semplice il tuo assortimento di utensili, scegliendo tra infinite combinazioni!

Provalo subito: vai su kitplanner.usag.it o clicca sul banner nella Home Page del sito usag.it

COME FUNZIONA?



Entra nel configuratore da PC o tablet



Scegli il contenitore: carrello o cassetta



Seleziona un assortimento suggerito o crealo liberamente



Esporta il tuo progetto in formato PDF o Excel



Contatta il tuo Rivenditore di fiducia per l'acquisto

Se sei già in possesso di un carrello o di una cassetta portautensili USAG, potrai configurare anche il solo assortimento.

Nella Home Page del **KIT PLANNER** e sul **canale YouTube** di **USAG**, troverai un **video tutorial** che ti guiderà al corretto utilizzo del software.



 YouTube

Articolo	Pag	Articolo	Pag	Articolo	Pag	Articolo	Pag	Articolo	Pag
0		285 KA/DS8	43	518 SP6A-S	8	519/127C	14	687 1/2 C16	60
001 RV	24	285 KB/SR8	44	518 SP6I-S	8	519/127N	14	688 3/4 MD6	60
001 TRV	24	285 KF/DS8	44	518 SP6V	18	519/150AX	14	692 J100	57
002 JMA	26	285 SE26	42	518 SP7V	18	519/200I	15	692 J32	57
002 JTMA	27	291 N/SE5	45	519 M 085EX	12	519/233A	14	692 J49	57
007 FTSV	25	294 AD	46	519 M 091A	12	519/234C	14	700	
007 SV	25	294 AG	46	519 M 127N	12	519/235LN	14	746	70
007 V	25	299 SE4	45	519 M 133AX	12	519/252A1	14	765	70
063 W	70	300		519 M 133AX1	12	519/276	15	800	
085 EX/SE2	31	302 N	73	519 M 150AX	12	519/280T	15	810 F	40
085 EX/SE3	31	305 N	73	519 M 233C24	12	519/280TK	14	810 N	40
091 D/SH5	30	307 A/S7	73	519 M 235M	12	519/283	14	812 N	40
091 SH5	30	308	73	519 M 235MC7	12	519/285A1	14	814 A	41
091 SH8	30	314 A	72	519 M 235MD7	12	519/285B2	14	824 A	41
100		314 DA	72	519 M 236K	12	519/285KA1	14	824 SK23	41
127 C/SE4	35	314 BM	72	519 M 236K1	12	519/285KF	14	870 C	81
127 C/SEAS	35	317 PH/SE4	29	519 M 236K2	12	519/291NA	14	871 AN	81
127 N/SE4	35	324 SH12	29	519 M 276	13	519/294	14	871 C	81
127 N/SE4S	35	324 SH8	28	519 M 280N1	12	519/299	14	871 D	81
135 A	36	324 STX/S7	29	519 M 280TK	12	519/322H	14	889 RD	66
136 M	36	342 SE8	70	519 M 285A1	12	519/322STX	14	889 RP	67
137	36	367 SE6	71	519 M 285A2	12	519/324H	15	889 RT	67
139 AN	36	368 B	71	519 M 285KA	12	519/324TX	15	889 SA	66
150 AX/SE2	33	382	71	519 M 285KF	12	519/366	15	889 TR	67
150 AX/SE3	32	400		519 M 291N13	13	519/382	15	900	
150 AX/SP2	33	443 B	76	519 M 322H	13	519/382F	15	913 PC2 1/2	65
150 CX/SE3	33	443 BC	76	519 M 322STX	13	519/607AEA	15	922 B1	65
155 AX	34	443 N	76	519 M 324H	13	519/607CA	15	928 AC1 1/2	63
200		443 NC	76	519 M 324STX	13	519/607CEA	15	928 D1 3/4	64
207 D	68	443 NC	76	519 M 333K	13	519/613AEA	15	929 PC1 1/2	63
207 E	68	444	76	519 M 382F	13	519/613BEA	15	939 C1	65
235 1/2 MN/C7	61	446 S28	77	519 M 458S20	13	519/613CEA	15	942 PC3 1/2	64
235 3/4 M/D7	61	447 T	78	519 M 612EB	13	519/615AEA	15	943 PC1 1/2	62
236 K 1/2	59	451 N/S4	74	519 M 612MPA	13	519/960	15	943 PC2 1/2	62
236 K 1/4	59	452	74	519 M 613AEA	13	519/990A1	15	995 AF	69
236 K/C13	59	454	74	519 M 613BEA	13	519/990AB1	15	995 AL	69
236 K/C20	59	458 E/B9	52	519 M 613CEA	13	531 A	23	1000	
236 K/C27	59	458 S20	53	519 M 688EC7	13	532 A	23	1613 AB12	78
237 1/2 AK	47	495 A-PL	11	519 M 929PC1	13	532 B	23	1785 B	80
237 1/4 AK	47	495 A-SP	10	519 M 942PC3	13	532 C	23	1950 C3	79
252 N/SR8	44	495 I-PL	11	519 M 995K	13	532 D	23	1950 C6	79
263 RA	77	495 I-SP	10	519 MSK6	12	600		2000	
263 S16	77	495 MA	10	519 R6/3A-S	9	601 1/2 J22	56	2000 A	82
270 B/C3	82	498 B	22	519 R6/3I-S	9	601 1/4 J34	56	2550 A	79
270 BM	82	500		519 R6/3NV	19	601 1/4-1/2 J100	54	2550 B	79
272 DS	83	502 R1V	21	519 R6/3V	19	601 1/4-1/2 J82	55	2847/3	80
276 CE/SE8	45	502 R2V	21	519 R6/4NV	19	601 1/4-1/2 JTX16	56	3000	
280 LTS/S9	37	504 S	20	519 R6/5V	19	606 1/2 EA	48	3500 S1P	75
280 LTSTX/S8	37	506 A2	22	519 R7/3V	19	606 1/4 EA	49		
280 T/SE7	38	506 A2C	22	519 R8/3V	19	606 1/4 SK	51		
280 TK/SE6	39	513 B6V	19	519 RA1	20	607 1/4 EB	50		
280 TSTX/SE4	39	514 B6V	20	519 RA2	20	609 1/4 EB	50		
280 TTS/SE6	39	516 SP6A-P	6	519 RA3	20	610 1/4 EFK	51		
280 XLTS/S9	37	516 SP6I-P	6	519 RA4	20	612 1/2 MPA	49		
285 DS8	42	516 SP6V	16	519 RA5	20	612 3/4 EB	49		
285 KA/DS12	43	516 SP6XLM	7	519 RA6	20	641 TA	24		
		516 SP6XLV	17	519 RA8	20	641 TB	24		
		516 SP7V	16	519 RA9	20	641 TC	24		
		516 SPC1	17	519 SKV6	14	646/5LV	23		
		516 SPC2	17	519/091H	14	654 RV	21		

SCOPRI LE NOVITÀ 2020

Estrattori per viti esagonali danneggiate



NEW

Pagina 42

Forbice per elettricisti



NEW

Pagina 68

Kit rimozione dadi e viti di antifurto



NEW

Pagina 83

Carrelli e assortimenti



NEW

Pagina 6

Banchi ed armadi



Pagina 21

Contenitori trasportabili



NEW

Pagina 23

Giraviti



NEW

Pagina 28

Pinze



NEW

Pagina 31

Chiavi maschio



Pagina 37

Dinamometria



Pagina 40

Chiavi di manovra



Pagina 44

Cricchetti e set di bussole



NEW

Pagina 49

Prolunghe a catena



Pagina 58

Pneumatica e bussole macchina



NEW

Pagina 60

Illuminazione



NEW

Pagina 66

Manutenzione



NEW

Pagina 69

Scarpe da lavoro



Pagina 75

Autoriparazione



NEW

Pagina 76



CERCA GLI ICONIC PRODUCT:
i prodotti che fanno la differenza!

Carrelli con assortimento



**NON TROVI IL
Vai subito su**



**RISPARMI
€ 100**

Rispetto all'acquisto di carrello ed assortimento separati.

**177
PEZZI**

516 SP6I-P
Cod. U05168020

**Carrello START con assortimento
MANUTENZIONE - 4 cassetti**

~~€ 1.705,49~~

€ 899,00



**RISPARMI
€ 100**

Rispetto all'acquisto di carrello ed assortimento separati.

**151
PEZZI**

516 SP6A-P
Cod. U05168021

**Carrello START con assortimento
AUTORIPARAZIONE - 3 cassetti**

~~€ 1.619,22~~

€ 859,00

ASSORTIMENTO MANUTENZIONE



519/613AEA 519/613CEA 519 SK692V

519/127N 519/150AX 519 SK692V

519/322H 519/322STX 519 SK692V

519/285A1 519/990A1 519/382F

692 J32

988 MA/S19

ASSORTIMENTO AUTORIPARAZIONE

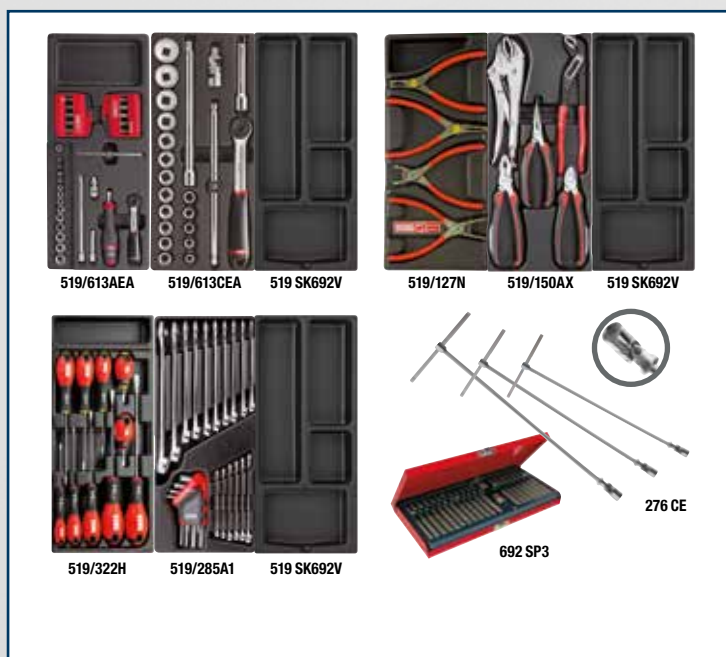

519/613AEA 519/613CEA 519 SK692V

519/127N 519/150AX 519 SK692V

519/322H 519/285A1 519 SK692V

692 SP3

276 CE

DESCRIZIONE

DESCRIZIONE	ART	PZ
Bussole esagonali, cricchetto (237 A 1/4"), accessori 1/4" ed inserti	519/613AEA	42
Bussole esagonali, cricchetto (237 A 1/2") e accessori 1/2"	519/613CEA	22
Pinze per anelli elastici	519/127N	4
Pinza universale, pinza regolabile, tronchese, pinza becchi lunghissimi, pinza grip	519/150AX	5
Giraviti a taglio e croce PH	519/322H	10
Giraviti TORX® Tamper Resistant	519/322STX	6
Chiavi combinate	519/285A1	25
Lima piatta, mezzotonda, tonda e triangolare	519/990A1	4
Martello, Mazzuola, Scalpelli e cacciaspine	519/382F	8
Assortimento di punte HSS-G	988 MA/S19	19
Assortimento di inserti con cricchetto reversibile	692 J32	32

DESCRIZIONE

DESCRIZIONE	ART	PZ
Bussole esagonali, cricchetto (237 A 1/4"), accessori 1/4" ed inserti	519/613AEA	42
Bussole esagonali, cricchetto (237 A 1/2") e accessori 1/2"	519/613CEA	22
Pinze per anelli elastici	519/127N	4
Pinza universale, pinza regolabile, tronchese, pinza becchi lunghissimi, pinza grip	519/150AX	5
Giraviti a taglio e croce PH	519/322H	10
Chiavi combinate	519/285A1	25
Assortimento di inserti RIBE con foro - XZN - TORX® Tamper Resistant	692 SP3	40
Chiavi a T snodate con bocca esagonale (10,13,17 mm)	276 CE	3

TUO ASSORTIMENTO IDEALE? kitplanner.usag.it e realizzalo!

NEW



**RISPARMI
€ 200**

Rispetto all'acquisto di
carrello ed assortimento
separati.

**318
PEZZI**

**516 SP6XLM
Cod. U05160111**

**Carrello START XL con assortimento
MANUTENZIONE - 4 cassettei**

~~€ 3.097,13~~

€ 1.599,00

ASSORTIMENTO MANUTENZIONE



519 M 612CLA

519 M 613BEA

519 M 613AEA



519 M 285KA

519 M 285A1

519 M 285A2

519 M 233C24

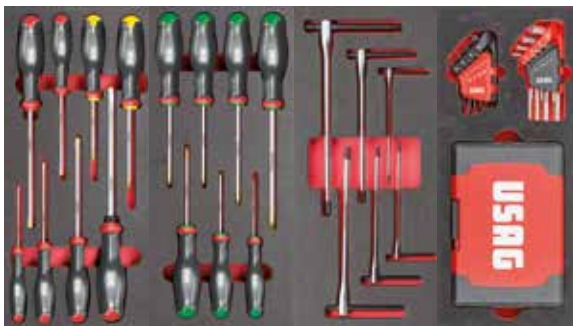

519 M 324H

519 M 324STX

519 M 280TK

519 M 280N1



519 M 127N

519 M 150AX

519 M 382F

519 M 990A5MD

DESCRIZIONE	ART	PZ
Bussole esagonali, cricchetto (237 A 1/4"), accessori 1/4" ed inserti	519 M 613AEA	46
Bussole esagonali, cricchetto (237 A 3/8") e accessori 3/8"	519 M 613BEA	20
Bussole esagonali, cricchetto (237 A 1/2") e accessori 1/2"	519 M 612CLA	35
Chiavi combinate 6÷24 mm	519 M 285A1	17
Chiavi combinate 27÷34 mm	519 M 285A2	5
Chiavi combinate a cricchetto reversibile 8÷19 mm	519 M 285KA	12
Chiavi a bussola TORX® e con inserto TORX®, XZN, esagonale, Ribe	519 M 233 C24	24
Giraviti a taglio e croce PH	519 M 324H	8

DESCRIZIONE	ART	PZ
Giraviti TORX® Tamper Resistant	519 M 324STX	7
Chiavi maschio a T con traversino scorrevole 2,5÷8 mm	519 M 280TK	6
Cassetta inserti assortita e chiavi maschio esagonali - TORX®	519 M 280N1	117
Pinze per anelli elastici interni ed esterni 19÷60	519 M 127N	4
Pinza universale, pinza regolabile, tronchese, pinza becchi lunghissimi, pinza grip	519 M 150AX	5
Lime a taglio mezzodolce	519 M 990A5MD	5
Martello per meccanici, mazzuola, cacciaspine, scalpello e bulino	519 M 382F	7

Vuoi solo l'assortimento? Vai a pagina 10

Carrelli con assortimento

NEW



**NON TROVI IL
Vai subito su**



**RISPARMI
€ 180**

Rispetto all'acquisto di carrello ed assortimento separati.



**RISPARMI
€ 180**

Rispetto all'acquisto di carrello ed assortimento separati.

**157
PEZZI**

518 SP6I-S
Cod. U05188022

**Carrello SPRINT con assortimento
MANUTENZIONE - 3 cassetti**

~~€ 1.928,68~~ **€ 979,00**

**149
PEZZI**

518 SP6A-S
Cod. U05188023

**Carrello SPRINT con assortimento
AUTORIPARAZIONE - 3 cassetti**

~~€ 1.986,78~~ **€ 919,00**

ASSORTIMENTO MANUTENZIONE



519 M 613AEA 519 M 613CEA 519 MSK6 519 M 285A1 519 M 150AX 519 MSK6



519 M 324H 519 M 324STX 519 MSK6



988 MA/S19

692 J32

ASSORTIMENTO AUTORIPARAZIONE



519 M 613AEA 519 M 613CEA 519 MSK6 519 M 285A1 519 M 150AX 519 MSK6



519 M 324H 519 M 324STX 519 MSK6

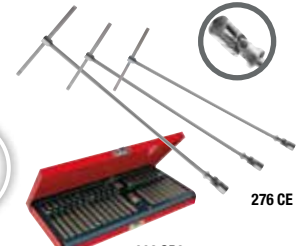

276 CE

692 SP3

MODULI IN SPUGNA BICOLORE

DESCRIZIONE	ART	PZ
Bussole esagonali, cricchetto (237 A 1/4"), accessori 1/4" ed inserti	519 M 613AEA	46
Bussole esagonali, cricchetto (237 A 1/2") e accessori 1/2"	519 M 613CEA	23
Chiavi combinate	519 M 285A1	17
Pinza universale, pinza regolabile, tronchese, pinza becchi lunghissimi, pinza grip	519 M 150AX	5
Giraviti a taglio e croce PH	519 M 324H	8
Giraviti TORX® Tamper Resistant	519 M 324STX	7
Assortimento di punte HSS-G	988 MA/S19	19
Assortimento di inserti con cricchetto reversibile	692 J32	32

DESCRIZIONE	ART	PZ
Bussole esagonali, cricchetto (237 A 1/4"), accessori 1/4" ed inserti	519 M 613AEA	46
Bussole esagonali, cricchetto (237 A 1/2") e accessori 1/2"	519 M 613CEA	23
Chiavi combinate	519 M 285A1	17
Pinza universale, pinza regolabile, tronchese, pinza becchi lunghissimi, pinza grip	519 M 150AX	5
Giraviti a taglio e croce PH	519 M 324H	8
Giraviti TORX® Tamper Resistant	519 M 324STX	7
Assortimento di inserti RIBE con foro - XZN - TORX® Tamper Resistant	692 SP3	40
Chiavi a T snodate con bocca esagonale (10,13,17 mm)	276 CE	3

Vuoi solo l'assortimento? Vai a pagina 10

TUO ASSORTIMENTO IDEALE? kitplanner.usag.it e realizzalo!



RISPARMI
€ 230

Rispetto all'acquisto di carrello ed assortimento separati.



RISPARMI
€ 230

Rispetto all'acquisto di carrello ed assortimento separati.

157
PEZZI

519 R6/3I-S
Cod. U05198022

Carrello RACING con assortimento MANUTENZIONE - 3 cassetti

€ 2.195,68 **€ 1.119,00**

149
PEZZI

519 R6/3A-S
Cod. U05198023

Carrello RACING con assortimento AUTORIPARAZIONE - 3 cassetti

€ 2.253,78 **€ 1.059,00**

ASSORTIMENTO MANUTENZIONE



ASSORTIMENTO AUTORIPARAZIONE

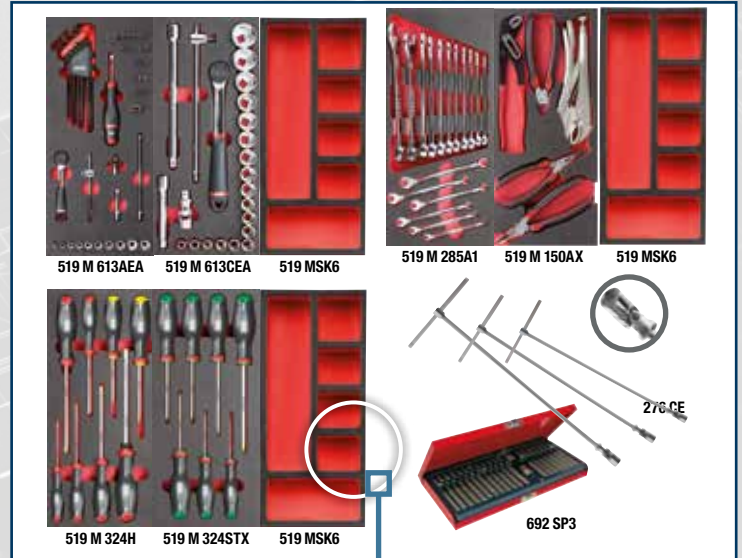

MODULI IN SPUGNA BICOLORE

DESCRIZIONE	ART	PZ
Bussole esagonali, cricchetto (237 A 1/4"), accessori 1/4" ed inserti	519 M 613AEA	46
Bussole esagonali, cricchetto (237 A 1/2") e accessori 1/2"	519 M 613CEA	23
Chiavi combinate	519 M 285A1	17
Pinza universale, pinza regolabile, tronchese, pinza becchi lunghissimi, pinza grip	519 M 150AX	5
Giraviti a taglio e croce PH	519 M 324H	8
Giraviti TORX® Tamper Resistant	519 M 324STX	7
Assortimento di punte HSS-G	988 MA/S19	19
Assortimento di inserti con cricchetto reversibile	692 J32	32

DESCRIZIONE	ART	PZ
Bussole esagonali, cricchetto (237 A 1/4"), accessori 1/4" ed inserti	519 M 613AEA	46
Bussole esagonali, cricchetto (237 A 1/2") e accessori 1/2"	519 M 613CEA	23
Chiavi combinate	519 M 285A1	17
Pinza universale, pinza regolabile, tronchese, pinza becchi lunghissimi, pinza grip	519 M 150AX	5
Giraviti a taglio e croce PH	519 M 324H	8
Giraviti TORX® Tamper Resistant	519 M 324STX	7
Assortimento di inserti RIBE con foro - XZN - TORX® Tamper Resistant	692 SP3	40
Chiavi a T snodate con bocca esagonale (10,13,17 mm)	276 CE	3

Vuoi solo l'assortimento? Vai a pagina 10

MODULI IN SPUGNA BICOLORE



519 M 613AEA 519 M 613CEA 519 MSK6



519 M 285A1 519 M 150AX 519 MSK6



519 M 324H 519 M 324STX 519 MSK6



988 MA/S19



692 J32

157
PEZZI



495 I-SP

Cod. U04950622

Assortimento INDUSTRIA - 3 cassetti

DESCRIZIONE	ART	PZ
Bussole esagonali, cricchetto (237 A 1/4"), accessori 1/4" ed inserti	519 M 613AEA	46
Bussole esagonali, cricchetto (237 A 1/2") e accessori 1/2"	519 M 613CEA	23
Chiavi combinate	519 M 285A1	17
Pinza universale, pinza regolabile, tronchese, pinza becchi lunghissimi, pinza grip	519 M 150AX	5
Giraviti a taglio e croce PH	519 M 324H	8
Giraviti TORX® Tamper Resistant	519 M 324STX	7
Assortimento di punte HSS-G	988 MA/S19	19
Assortimento di inserti con cricchetto reversibile	692 J32	32

~~€ 1.042,28~~

€ 660,00



519 M 613AEA 519 M 613CEA 519 MSK6



519 M 285A1 519 M 150AX 519 MSK6



519 M 324H 519 M 324STX 519 MSK6

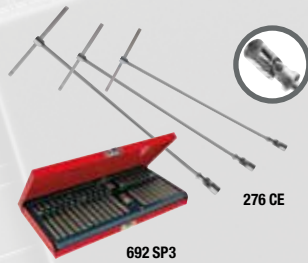

692 SP3



276 CE

149
PEZZI



495 A-SP

Cod. U04950623

Assortimento AUTORIPARAZIONE - 3 cassetti

DESCRIZIONE	ART	PZ
Bussole esagonali, cricchetto (237 A 1/4"), accessori 1/4" ed inserti	519 M 613AEA	46
Bussole esagonali, cricchetto (237 A 1/2") e accessori 1/2"	519 M 613CEA	23
Chiavi combinate	519 M 285A1	17
Pinza universale, pinza regolabile, tronchese, pinza becchi lunghissimi, pinza grip	519 M 150AX	5
Giraviti a taglio e croce PH	519 M 324H	8
Giraviti TORX® Tamper Resistant	519 M 324STX	7
Assortimento di inserti RIBE con foro - XZN - TORX® Tamper Resistant	692 SP3	40
Chiavi a T snodate con bocca esagonale (10,13,17 mm)	276 CE	3

~~€ 1.100,38~~

€ 600,00

ASSORTIMENTO PER CARRELLI 4 MODULI



519 M 612CLA 519 M 613BEA 519 M 613AEA



519 M 285KA 519 M 285A1 519 M 285A2 519 M 233C24



519 M 324H 519 M 324STX 519 M 280TK 519 M 280N1



519 M 127N 519 M 150AX 519 M 382F 519 M 990A5MD

318
PEZZI

495 MA

Cod. U04950023

**Assortimento
MANUTENZIONE
4 cassetti**

~~€ 2.368,13~~

€ 1.309,00



MODULI IN PLASTICA



519/613AEA 519/613CEA 519 SK692V 519/127N 519/150AX 519 SK692V



519/322H 519/322STX 519 SK692V 519/285A1 519/990A1 519/382F

692 J32



988 MA/S19



519/613AEA 519/613CEA 519 SK692V 519/127N 519/150AX 519 SK692V



519/322H 519/285A1 519 SK692V

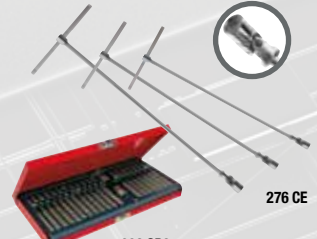

276 CE

692 SP3

177
PEZZI



495 I-PL
Cod. U04950620

Assortimento INDUSTRIA - 4 cassetti

DESCRIZIONE	ART	PZ
Bussole esagonali, cricchetto (237 A 1/4"), accessori 1/4" ed inserti	519/613AEA	42
Bussole esagonali, cricchetto (237 A 1/2") e accessori 1/2"	519/613CEA	22
Pinze per anelli elastici	519/127N	4
Pinza universale, pinza regolabile, tronchese, pinza becchi lunghissimi, pinza grip	519/150AX	5
Giraviti a taglio e croce PH	519/322H	10
Giraviti TORX® Tamper Resistant	519/322STX	6
Chiavi combinate	519/285A1	25
Lima piatta, mezzotonda, tonda e triangolare	519/990A1	4
Martello, Mazzuola, Scalpelli e cacciaspine	519/382F	8
Assortimento di punte HSS-G	988 MA/S19	19
Assortimento di inserti con cricchetto reversibile	692 J32	32

~~€ 1.114,49~~

€ 604,00

151
PEZZI



495 A-PL
Cod. U04950621

Assortimento AUTORIPARAZIONE - 4 cassetti

DESCRIZIONE	ART	PZ
Bussole esagonali, cricchetto (237 A 1/4"), accessori 1/4" ed inserti	519/613AEA	42
Bussole esagonali, cricchetto (237 A 1/2") e accessori 1/2"	519/613CEA	22
Pinze per anelli elastici	519/127N	4
Pinza universale, pinza regolabile, tronchese, pinza becchi lunghissimi, pinza grip	519/150AX	5
Giraviti a taglio e croce PH	519/322H	10
Chiavi combinate	519/285A1	25
Assortimento di inserti RIBE con foro - XZN - TORX® Tamper Resistant	692 SP3	40
Chiavi a T snodate con bocca esagonale (10,13,17 mm)	276 CE	3

~~€ 1.028,22~~

€ 564,00

DESCRIZIONE	ART	PZ
Bussole esagonali, cricchetto (237 A 1/4"), accessori 1/4" ed inserti	519 M 613AEA	46
Bussole esagonali, cricchetto (237 A 3/8") e accessori 3/8"	519 M 613BEA	20
Bussole esagonali, cricchetto (237 A 1/2") e accessori 1/2"	519 M 612CLA	35
Chiavi combinate 6÷24 mm	519 M 285A1	17
Chiavi combinate 27÷34 mm	519 M 285A2	5
Chiavi combinate a cricchetto reversibile 8÷19 mm	519 M 285KA	12
Chiavi a bussola TORX® e con inserto TORX®, XZN, esagonale, Ribe	519 M 233 C24	24
Giraviti a taglio e croce PH	519 M 324H	8
Giraviti TORX® Tamper Resistant	519 M 324STX	7
Chiavi maschio a T con traversino scorrevole 2,5÷8 mm	519 M 280TK	6
Cassetta inserti assortita e chiavi maschio esagonali - TORX®	519 M 280N1	117
Pinze per anelli elastici interni ed esterni 19÷60	519 M 127N	4
Pinza universale, pinza regolabile, tronchese, pinza becchi lunghissimi, pinza grip	519 M 150AX	5
Lime a taglio mezzodolce	519 M 990A5MD	5
Martello per meccanici, mazzuola, cacciaspine, scalpello e bulino	519 M 382F	7



NON TROVI IL TUO ASSORTIMENTO IDEALE?

Vai subito su
kitplanner.usag.it
e realizzalo!

Moduli in spugna



519 MSK6
Cod.U05190910Q

Modulo portaminuterie

€ 20,40 € 14,30



5 PEZZI
519 M 085EX
Cod.U05191010

081 EX 160 · 134 250 · 085 EX 180 · 180 C 250 · 087 EX 160.

€ 167,90 € 118,00



8 PEZZI
519 M 091A
Cod.U05191016

091 0,5x3x75-0,8x4x100-1x5,5x125 · 1,2x6,5x150 · 091 PH 1x100-2x125 · 091 PZ 1x100-2x125.

€ 79,40 € 55,50



4 PEZZI
519 M 127N
Cod.U05190937

127 N 19=60 · 127 PN 19=60 · 128 N 19=60 · 128 PN 19=60.

€ 98,60 € 69,00



4 PEZZI
519 M 133AX
Cod.U05191003

133 AX 160 · 135 B 250 · 150 AX 180 · 180 B 250.

€ 168,80 € 118,00



4 PEZZI
519 M 133AX1
Cod.U05191004

133 AX 160 · 180 B 250 · 188 AX 160 · 211 B.

€ 127,00 € 88,90



5 PEZZI
519 M 150AX
Cod.U05190965

133 AX 160 · 134 250 · 150 AX 180 · 180 C 250 · 188 AX 160.

€ 142,80 € 100,00



24 PEZZI
519 M 233C24
Cod.U05191002

233 1/2 NS 9L-10L · 233 1/2" NTX T40L-T45L-T55L-T70L · 233 1/2 NXZN 6L-8L-10L-12L-14L · 234 1/2 N 6L-7L-8L-10L-12L 235 1/2 NTX E12-E14-E16-E18-E20 · 235 1/4 TX E8 · 235 3/8 NTX E8-E10.

€ 310,28 € 217,00



22 PEZZI
519 M 235M
Cod.U05191009

235 1/2 M 10-11-12-13-14-15-16-17-18-19-22-24 · 235 1/2 MLS 15-17-19-21-22-24 · 235 MCA 4-6 · 235 MDA 4-6.

€ 257,55 € 180,00

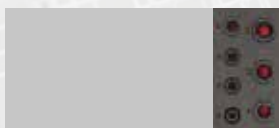

7 PEZZI
519 M 235MC7
Cod.U05191026

235 1/2 M 10-13-14-17-19-22-24.

€ 79,00 € 55,00



7 PEZZI
519 M 235MD7
Cod.U05191028

235 3/4 M 17-19-22-24-27-30-32.

€ 167,00 € 117,00

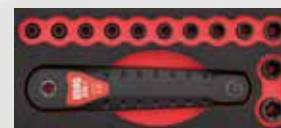

13 PEZZI
519 M 236K
Cod.U05190236

235 1/2 M 10-11-12-13-14-15-16-17-18-19-22-24 · 236 K 1/2".

€ 235,15 € 164,60



27 PEZZI
519 M 236K1
Cod.U05190238

237 A 235 1/4 EN 5,5-6-7-8-9-10-11-12-13-14 · 236 1/4" 50-100 · 236 K 1/4" · 237 A 1/4" · 660 E 3-4-5-6-7 · 660 PH 1-2-3 · 660 STX T15-T20-T25-T30 · 684 1/4".

€ 206,41 € 144,50



20 PEZZI
519 M 236K2
Cod.U05190239

237 A 235 1/2 EN 10-11-12-13-14-15-16-17-18-19-21-22-24-27-30-32 · 236 1/2" 125 · 236 K 1/2" · 237 A 1/2" · 241 1/2".

€ 287,02 € 200,90



117 PEZZI
519 M 280N1
Cod.U05191013

280 S9 1,5-2-2,5-3-4-5-6-8-10 · 280 TX/ S8C T10-T15-T20-T25-T27-T30-T40-T45 · 692 J100.

€ 112,96 € 79,00



6 PEZZI
519 M 280TK
Cod.U05190935

280 TK 2,5-3-4-5-6-8.

€ 100,60 € 70,40



17 PEZZI
519 M 285A1
Cod.U05190921

285 6-7-8-9-10-11-12-13-14-15-16-17-18-19-21-22-24.

€ 153,03 € 109,00



5 PEZZI
519 M 285A2
Cod.U05190943

285 27-29-30-32-34.

€ 128,10 € 90,00



12 PEZZI
519 M 285KA
Cod.U05190944

285 KA 8-9-10-11-12-13-14-15-16-17-18-19.

€ 214,10 € 150,00



12 PEZZI
519 M 285KF
Cod.U05190964

285 KF 8-9-10-11-12-13-14-15-16-17-18-19.

€ 251,10 € 176,00



CREA IL TUO ASSORTIMENTO IDEALE:

Questa è solo una selezione dei 180 moduli disponibili su kitplanner.usag.it!



13
PEZZI

519 M 291N13
Cod.U05191001

291 N 7-8-9-10-11-12-13-14-15-16-17-18-19.

€ 213,70 € 149,00

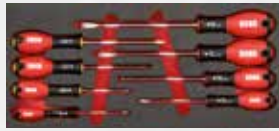

8
PEZZI

519 M 322H
Cod.U05190927

322 O,5x3x75-0,8x4x100-1x5,5x125-1,2x6,5x150-1,6x8x175 · 322 PH 0x75-1x100-2x125.

€ 46,67 € 32,70



6
PEZZI

519 M 322STX
Cod.U05190929

322 STX T10x75-T15x75-T20x100-T25x100-T30x125-T40x125.

€ 53,26 € 37,30



8
PEZZI

519 M 324H
Cod.U05190910

324 O,5x3x75-0,8x4x100-1x5,5x125-1,2x6,5x150 · 324 PH 1x100-2x125 · 324 D 0,6x3,5x100 324 E 1,6x8x175.

€ 63,10 € 44,10



7
PEZZI

519 M 324STX
Cod.U05190911

324 STX T10x75-T15x75-T20x100-T25x100-T27x100-T30x125-T4x150.

€ 94,00 € 65,80



23
PEZZI

519 M 333K
Cod.U05190978

333 K · 333 E 2,5-3-4-5-6 · 333 PH 0-1-2-3 · 333 STX T7-T8-T9-T10-T15-T20-T25-T27-T30-T40 · 333 1/4 Q · 333 1/4 MG · 660 0,6x4,5-1x5,5-1,2x6,5-1,6x8 · 660 PZ 0-1-2-3.

€ 186,15 € 130,30



7
PEZZI

519 M 382F
Cod.U05190926

362 175 · 367 2x100-3x130-6x180 · 368 3x100 · 376 28 · 382F 500.

€ 103,62 € 72,00



20
PEZZI

519 M 458S20
Cod.U05191033

458 B 3/8 8-10-11-12-13-14 · 458 B 1/2 15-16-17-18-19 · 458 E 2-2,5-3-4-5-6-7-8 · 684 1.

€ 177,00 € 124,00



46
PEZZI

519 M 613AEA
Cod.U05190940

237 A · 235 1/4" EN 5,5-6-7-8-9-10-11-12-13-14 · 236 1/4" 50-100 · 237 A 1/4" · 240 1/4" · 241 1/4" · 243 1/4" · 280 LTS/S9 · 684 1/4"-1/4" · 660 0,6-1-1,6 · 660 E 3-4-5-6-8 · 660 PH 1-2-3 · 660 PZ 1-2-3 · 660 STX T15-T20-T25-T27-T30-T40.

€ 209,42 € 146,00



46
PEZZI

519 M 613AEB
Cod.U05190924

237 B · 235 1/4" EN 5,5-6-7-8-9-10-11-12-13-14 · 236 1/4" 50-100 · 237 B 1/4" · 240 1/4" · 241 1/4" · 243 1/4" · 280 LTS/S9 · 684 1/4"-1/4" · 660 0,6-1-1,6 · 660 E 3-4-5-6-8 · 660 PH 1-2-3 · 660 PZ 1-2-3 · 660 STX T15-T20-T25-T27-T30-T40.

€ 215,32 € 150,00



20
PEZZI

519 M 613BEA
Cod.U05190928

237 A · 235 3/8" E 7-8-9-10-11-12-13-14-15-16-17-18-19-21-22 · 236 3/8" 125-250 · 237 A 3/8" · 240 3/8" N · 241 3/8".

€ 180,32 € 126,00



23
PEZZI

519 M 613CEA
Cod.U05190942

237 A · 235 1/2" EN 8-10-11-12-13-14-15-16-17-18-19-21-22-23-24-27-30-32 · 236 1/2" 125-250 · 237 A 1/2" · 240 1/2" N · 241 1/2".

€ 228,53 € 160,00

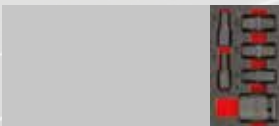

6
PEZZI

519 M 688ED6
Cod.U05191030

685 B 1 7/8 · 688 E 12-17-19-22-24

€ 79,00 € 55,00



1/2"

519 M 929PC1
Cod.U05191007

Avvitatore ad impulsi in magnesio 929 PC1 1/2".

€ 345,20 € 235,00



1/2"

519 M 942PC3
Cod.U05191008

Avvitatore ad impulsi extra compatto 942 PC3 1/2".

€ 226,20 € 164,00



501
PEZZI

519 M 995K
Cod.U05190139

995 A · 995 AL 3x8 (100) · 995 AL 3x10 (100) · 995 AL 4x10 (100) · 995 AL 4x12 (100) · 995 AL 4,8x12 (100).

€ 49,10 € 34,30



17
PEZZI

519 M 612EB
Cod.U05190990

235 3/4" N 22-23-24-26-27-28-30-32-36-38-41-46-50 · 236 3/4" 200-400 · 237 B 3/4 · 240 3/4 N.

€ 452,50 € 317,00



35
PEZZI

519 M 612MPA
Cod.U05190986

235 1/2" N 10-11-12-13-14-15-16-17-18-19-22-24-27-30-32 · 235 1/2" PN 3/8-7/16-1/2-9/16-5/8-11/16-3/4-13/16-7/8-15/16-1-1 1/16-1 1/8-1 3/16-1 1/4 · 236 1/2" 125-250 · 237 A 1/2" · 240 1/2" N · 241 1/2".

€ 325,99 € 228,00

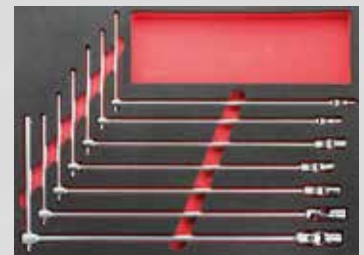

7
PEZZI

519 M 276
Cod.U05190936

276 CE 7-8-10-11-13-17-19.

€ 210,80 € 155,00

Bussole in
millimetri
e pollici

Moduli in plastica



519 SKV6
Cod.U05190827
Vaschetta portaminuterie

€ 11,60 € 8,10



9 PEZZI 519/091H
Cod.U05190758

091 0,4x2,5x50-0,5x3x75 0,6x3,5x100-0,8x4x100-1x5,5x125-1,2x6,5x150 · 091 PH 0x75-1x100-2x125.

€ 75,82 € 53,00



4 PEZZI 519/127C
Cod.U05190717

127 C 19÷60 · 127 CP 19÷60 · 128 C 19÷60 · 128 CP 19÷60.

€ 79,80 € 55,50



4 PEZZI 519/127N
Cod.U05190716

127 N 19÷60 · 127 PN 19÷60 · 128 N 19÷60 · 128 PN 19÷60.

€ 94,50 € 66,00



5 PEZZI 519/150AX
Cod.U05190850

133 AX 160 · 134 250 · 150 AX 180 · 180 C 250 · 188 AX 160.

€ 138,70 € 97,10



15 PEZZI 519/233A
Cod.U05190820

233 1/2 NS 9L-10L · 233 1/2" NTX T40L-T45L-T55L-T70L · 233 1/2 NXZN 6L-8L-10L-12L-14L · 234 1/2 N 5L2-6L-7L-8L.

€ 242,60 € 170,00



22 PEZZI 519/234C
Cod.U05190720

233 1/2" NTX T27-T30-T40-T45-T50-T55-T60 · 234 1/2" N 5-6-7-8-10-12-14-17 · 235 1/2" NTX E10-E12-E14-E16-E18-E20-E24.

€ 235,91 € 165,00



10 PEZZI 519/235LN
Cod.U05190829

235 1/2 LN 10-11-12-13-14-15-16-17-19-22..

€ 142,40 € 99,70



11 PEZZI 519/252A1
Cod.U05190821

252 N 6x7-8x9-10x11-12x13-14x15-16x17-18x19-21x23-22x24-27x29-30x32.

€ 96,87 € 67,80



6 PEZZI 519/280TK
Cod.U05190787

280 TK 2,5-3-4-5-6-8.

€ 96,50 € 67,60



8 PEZZI 519/283
Cod.U05190899

283 N 6x7-8x9-8x10-10x11-12x13-14x15-16x17-18x19.

€ 88,99 € 62,00



25 PEZZI 519/285A1
Cod.U05190785

285 6-7-8-9-10-11-12-13-14-15-16-17-18-19-22-24 280 S9 1,5÷10.

€ 156,33 € 111,00



4 PEZZI 519/285B2
Cod.U05190823

285 27-29-30-32.

€ 89,60 € 62,50



12 PEZZI 519/285KA1
Cod.U05190788

285 KA 8-9-10-11-12-13-14-15-16-17-18-19.

€ 210,00 € 147,00



12 PEZZI 519/285KF
Cod.U05190851

285 KF 8-9-10-11-12-13-14-15-16-17-18-19.

€ 247,00 € 173,00



10 PEZZI 519/291NA
Cod.U05190824

291 N 8-10-11-12-13-14-16-17-18-19.

€ 168,80 € 118,00



9 PEZZI 519/294
Cod.U05190732

204 250 · 294 A 250 · 367 2x110-3x130-4x145-5x165-6x180-8x200 · 981 A3.

€ 103,54 € 72,50



5 PEZZI 519/299
Cod.U05190760

299 6-7-8-10-13.

€ 78,40 € 55,00



10 PEZZI 519/322H
Cod.U05190772

322 0,5x3x75-0,8x4x100-1x5,5x125-1,2x6,5x150-1,6x8x175 · 322 PH 0x75-1x100-2x125 · 322 N 0,8x4x30 · 322 NPH 2x30.

€ 51,47 € 36,00



6 PEZZI 519/322STX
Cod.U05190831

322 STX T10-T15-T20-T25-T30-T40.

€ 48,96 € 34,30

NEW



CREA IL TUO ASSORTIMENTO IDEALE:

Questa è solo una selezione dei 180 moduli disponibili su kitplanner.usag.it!

Moduli in plastica



10 PEZZI
519/324H
Cod.U05190763
 324 0,5x3x75-0,8x4x100-1x5,5x125-1,2x6,5x150-1,2x8x200 · 324 PH 0x75-1x75-2x100 · 324 N 0,8x4x35 · 324 NPH 2x35.
 € 66,66 **€ 46,50**



9 PEZZI
519/324TX
Cod.U05190764
 324 TX T6x50-T7x50-T8x50-T9x75 · 324 STX T10x75-T15x75-T20x100-T25x100-T30x125.
 € 94,51 **€ 66,00**



7 PEZZI
519/366
Cod.U05190740
 351 200 · 362 125-150 · 364 125 · 366 3x125 · 4x150 · 368 4x125.
 € 67,45 **€ 47,20**



2 PEZZI
519/382
Cod.U05190741
 376 35 · 382 500.
 € 39,70 **€ 27,80**



8 PEZZI
519/382F
Cod.U05190742
 362 150 · 367 2x110-3x130-4x145-5x165 · 368 4x125 · 376 35 · 382F 500.
 € 85,28 **€ 59,70**



44 PEZZI
519/607AEA
Cod.U05190790
 237 A 235 1/4" EN 4-4,5-5-5,5-6-7-8-9-10-11-12-13-14 · 235 1/4" EL 5-6-7-8-9-10-11-12-13-14 · 236 1/4" 50-100-150 · 237 A 1/4 · 240 1/4" · 241 1/4" · 243 1/4" · 660 0,6x4,5-0,8x5,5-1x5,5-1,2x5,5 · 660 E 2,5-3-4-5-6 · 660 PH 1-2-3 · 684 1/4"-1/4" · 236 1/4" SN.
 € 252,03 **€ 177,00**



30 PEZZI
519/607CA
Cod.U05190810
 237 A 235 1/2" N 8-9-10-11-12-13-14-15-16-17-18-19-20-21-22-23-24-26-27-28-29-30-32-34 · 236 1/2" 125-250 · 237 A 1/2" · 239 1/2" N · 240 1/2" N · 241 1/2".
 € 286,14 **€ 200,00**



30 PEZZI
519/607CEA
Cod.U05190811
 237 A 235 1/2" EN 8-9-10-11-12-13-14-15-16-17-18-19-20-21-22-23-24-26-27-28-29-30-32-34 · 236 1/2" 125-250 · 237 A 1/2" · 239 1/2" N · 240 1/2" N · 241 1/2".
 € 287,37 **€ 201,00**



49 PEZZI
519/607ICEA
Cod.U05190841
 237 A 235 1/2 EN 8-10-11-12-13-14-15-16-17-18-19-21-22-23-24-27-30-32 · 236 1/2 125-250 · 237 A 1/2 · 240 1/2 N · 241 1/2 · 661 0,8x5,5-1x6,5-1,2x8-1,6x10 · 661 E 5-6-8-10 · 661 PH 1-2-3 · 661 PZ 1-2-3 · 661 TX T27-T30-T40-T45-T50-T55 · 664 EL 5-6-7-8-10 · 684 1/2-5/16.
 € 326,65 **€ 233,00**



42 PEZZI
519/613AEA
Cod.U05190784
 237 A 235 1/4" EN 4-4,5-5-5,5-6-7-8-9-10-11-12-13-14 · 236 1/4" 50-150 · 237 A 1/4" · 240 1/4" · 241 1/4" · 243 1/4" · 692 S11 · 692 STX/S11 · 684 1/4"-1/4".
 € 179,00 **€ 125,00**



21 PEZZI
519/613BEA
Cod.U05190747
 237 A 235 3/8" E 6-7-8-9-10-11-12-13-14-15-16-17-18-19-21-22 · 236 3/8" 125-250 · 237 A 3/8" · 240 3/8" N · 241 3/8".
 € 181,43 **€ 127,00**



22 PEZZI
519/613CEA
Cod.U05190750
 237 A 235 1/2" EN 10-11-12-13-14-15-16-17-18-19-20-21-22-24-27-30-32 · 236 1/2" 125-250 · 237 A 1/2" · 240 1/2" N · 241 1/2".
 € 218,42 **€ 153,00**



52 PEZZI
519/615AEA
Cod.U05190837
 237 A 235 1/4 EN 5,5-6-7-8-9-10-11-12-13-14 · 236 1/4 50-150 · 237 A 1/4 · 240 1/4 · 241 1/4 · 243 1/4 · 280 LTS/S9 · 280 LTSTX/S8 · 660 0,5x4-1x5,5 · 660 E 3-4-5-6-8 · 660 PH 1-2-3 · 660 PZ 1-2 · 660 STX T10-T15-T20-T25-T30-T40 · 684 1/4.
 € 252,81 **€ 177,00**



7 PEZZI
519/960
Cod.U05190753
 207 A · 220 B1 · 960 · 966 20 · 974 · 978 A 200 · 981 A 3.
 € 131,33 **€ 91,50**



4 PEZZI
519/990A1
Cod.U05190825
 990 M PA/200 · 990 M PB/200 · 990 M PC/200 · 990 M PE/200.
 € 50,13 **€ 35,10**



4 PEZZI
519/990AB1
Cod.U05190826
 990 B PA/200 · 990 B PB/200 · 990 B PC/200 · 990 B PE/200.
 € 49,26 **€ 34,50**



11 PEZZI
519/200I
Cod.U05190715
XXL
 200 S · 207 A · 362 125-150 · 364 125 · 366 3x125-4x150 · 368 4x125 · 376 35 · 382 500 · 966 20.
 € 138,34 **€ 96,80**



8 PEZZI
519/276
Cod.U05190725
XXL
 276 CE 7-8-10-11-13-14-17-19.
 € 234,80 **€ 166,00**



8 PEZZI
519/280T
Cod.U05190727
XL
 280 T 2-2,5-3-4-5-6-8-10.
 € 137,40 **€ 96,00**



YouTube

START⁵¹⁶



7
CASSETTI

516 SP7V

Cod. U05160007

3
MODULI

Carrello START (vuoto)

- Dimensioni interne:
 - 5 cassetti 570x420x60 mm.
 - 1 cassetto 570x420x130 mm.
 - 1 cassetto 570x420x200 mm.

~~€ 673,00~~

€ 435,00



MANIGLIE BASCULANTI IN ABS



6
CASSETTI

516 SP6V

Cod. U05160006

3
MODULI

Carrello START (vuoto)

- Dimensioni interne:
 - 3 cassetti 570x420x60 mm.
 - 2 cassetti 570x420x130 mm.
 - 1 cassetto 570x420x200 mm.

~~€ 591,00~~

€ 395,00



RISPARMIA IL TUO TEMPO

Tutti i carrelli a cassettera USAG sono subito pronti all'uso, perchè forniti con le ruote già montate alla struttura.





NEW

6
CASSETTI

516 SP6XLV

Cod. U05160011



4
MODULI

Carrello Start XL (vuoto)

- Dimensioni interne cassetti:
 - 3 cassetti 760x420x60 mm.
 - 2 cassetto 760x420x130 mm.
 - 1 cassetto 760x420x270 mm.

~~€ 729,00~~

€ 490,00

ACCIAIO



6
CASSETTI

516 SPC2

Cod. U05160021



3
MODULI

Banco da lavoro START con piano in acciaio

- Dimensioni interne cassetti:
 - 3 cassetti 570x420x60 mm.
 - 2 cassetti 570x420x130 mm.
 - 1 cassetto 570x420x200 mm.

~~€ 1.121,00~~

€ 750,00

LEGNO



6
CASSETTI

516 SPC1

Cod. U05160020



3
MODULI

Banco da lavoro START con piano in legno

- Dimensioni interne cassetti:
 - 3 cassetti 570x420x60 mm.
 - 2 cassetti 570x420x130 mm.
 - 1 cassetto 570x420x200 mm.

~~€ 1.121,00~~

€ 750,00



SPRINT⁵¹⁸

YouTube



7
CASSETTI
518 SP7V
Cod. U05180107

3
MODULI
Carrello SPRINT (vuoto)

- Dimensioni interne:
 - 5 cassetti 570x420x60 mm.
 - 1 cassetto 570x420x130 mm.
 - 1 cassetto 570x420x200 mm.

~~€ 805,00~~

€ 549,00



**MANIGLIE FISSE
IN ALLUMINIO ANODIZZATO**



6
CASSETTI
518 SP6V
Cod. U05180106

3
MODULI
Carrello SPRINT (vuoto)

- Dimensioni interne:
 - 4 cassetti 570x420x60 mm.
 - 1 cassetto 570x420x130 mm.
 - 1 cassetto 570x420x270 mm.

~~€ 713,00~~

€ 499,00



RISPARMIA IL TUO TEMPO

Tutti i carrelli a cassetiera USAG sono subito pronti all'uso, perchè forniti con le ruote già montate alla struttura.



Racing 519



YouTube



72 kg | 774 mm | 971 mm | 546 mm

6 CASSETTI

519 R6/3V ●

Cod. U05190414

Carrello RACING (vuoto)

3 MODULI

519 R6/3NV ●

Cod. U05190424

Carrello RACING (vuoto)

- Dimensioni interne:
 - 4 cassetti 570x420x60 mm.
 - 1 cassetto 570x420x130 mm.
 - 1 cassetto 570x420x270 mm.

~~€ 980,00~~ € 689,00



83 kg | 964 mm | 971 mm | 546 mm

6 CASSETTI

519 R6/4V ●

Cod. U05190419

Carrello RACING (vuoto)

4 MODULI

519 R6/4NV ●

Cod. U05190429

Carrello RACING (vuoto)

- Dimensioni interne:
 - 4 cassetti 760x420x60 mm.
 - 1 cassetto 760x420x130 mm.
 - 1 cassetto 760x420x270 mm.

~~€ 1.141,00~~ € 799,00



94 kg | 1154 mm | 1000 mm | 546 mm

6 CASSETTI

519 R6/5V ●

Cod. U05190420

Carrello RACING (vuoto)

5 MODULI

- Dimensioni interne:
 - 3 cassetti 950x420x60 mm.
 - 2 cassetti 950x420x130 mm.
 - 1 cassetto 950x420x200 mm.

~~€ 1.471,00~~

€ 1.029,00



74 kg | 774 mm | 971 mm | 546 mm

7 CASSETTI

519 R7/3V ●

Cod. U05190415

Carrello RACING (vuoto)

3 MODULI

- Dimensioni interne:
 - 5 cassetti 570x420x60 mm.
 - 1 cassetto 570x420x130 mm.
 - 1 cassetto 570x420x200 mm.

~~€ 1.075,00~~ € 749,00



76 kg | 774 mm | 971 mm | 546 mm

6 CASSETTI

519 R8/3V ●

Cod. U05190416

Carrello RACING (vuoto)

4 MODULI

- Dimensioni interne:
 - 6 cassetti 570x420x60 mm.
 - 2 cassetti 570x420x130 mm.

~~€ 1.169,00~~ € 819,00



94 kg | 1154 mm | 1000 mm | 546 mm

6 CASSETTI

513 B6V ●

Cod. U05130096

Carrello BOOSTER (vuoto)

3 MODULI

- Dimensioni interne:
 - 4 cassetti 570x420x60 mm.
 - 1 cassetto 570x420x130 mm.
 - 1 cassetto 570x420x270 mm.
- Vano laterale: 380x400x720 mm.

~~€ 1.470,00~~

€ 1.029,00

Carrelli portautensili

18 kg
750 mm
950 mm
450 mm



3
RIPIANI

504 S

Cod. U05040003

Carrello multiuso

- Ripiani protetti con materiale plastico ad alta resistenza.
- Maniglia in acciaio per una maggiore manovrabilità.
- Due ruote pivotanti (Ø 100 mm) e due ruote fisse (Ø 100 mm).
- Fornito smontato.

~~€ 164,00~~

€ 119,00

1000 kg



128 kg
1.212 mm
1000 mm
670 mm

6
CASSETTI

514 B6V

Cod. U05140001

Banco da lavoro mobile BULL (vuoto)

- Piano di lavoro in legno multistrato.
- Portata massima cassetti: 20 kg.
- Vano laterale: 380x704x524 mm.
- Dimensioni interne:
 - 3 cassetti 570x420x60 mm.
 - 2 cassetti 570x420x130 mm.
 - 1 cassetto 570x420x200 mm.

~~€ 1.869,00~~

€ 1.309,00

ACCESSORI CARRELLI



519 RA1

Cod. U05190207

Portarifiuti

per Racing, Sprint, Start, Booster e Bull.

€ 87,00

€ 61,00



519 RA2

Cod. U05190208

Portadocumenti

per Racing, Sprint, Start, Booster e Bull.

€ 48,30

€ 33,80



519 RA3

Cod. U05190209

Pannello superiore

per Racing (3 moduli).

€ 138,00

€ 96,60



519 RA4

Cod. U05190210

Portarotolo

per Racing, Sprint, Start, Booster e Bull.

€ 51,00

€ 35,70



519 RA5

Cod. U05190211

Portaflaconi

per Racing, Sprint, Start, Booster e Bull.

€ 76,50

€ 53,60



519 RA6

Cod. U05190217

Piano appoggio pieghevole

per Racing e Sprint.

€ 138,00

€ 96,60



519 RA8

Cod. U05190219

Supporto per documenti

per Racing.

€ 55,00

€ 38,50



519 RA9

Cod. U05190218

Piano in legno per morsa

per Racing.

€ 138,00

€ 96,60



**MANIGLIA
IN ALLUMINIO**

1
CASSETTO

502 R1V

Cod. U05020001

Armadio vuoto - 1 cassetto

- Pannelli forati interni.
- Apertura a 180° delle ante.
- Cassetto ad estrazione totale.
- Guide telescopiche a sfera.
- Maniglia cassetto in alluminio anodizzato.
- Chiusura a serratura centralizzata.
- Possibilità di ancoraggio a parete o posizionamento su carrelli Racing 519R a 3 moduli (con kit tubi di montaggio U050100193).
- Ante verniciate colore rosso RAL 3020.
- Ganci e supporti non inclusi.
- Dimensioni interne cassetto: 569x210x60 mm.

~~€ 750,00~~

€ 525,00



**MANIGLIE
IN ALLUMINIO**

2
CASSETTI

502 R2V

Cod. U05020003

Armadio vuoto - 2 cassette

- Pannelli forati interni.
- Tapparella in plastica a scorrimento orizzontale.
- Maniglia tapparella in metallo.
- Struttura in lamiera d'acciaio verniciata RAL 3020.
- Possibilità di ancoraggio a parete.
- Ganci e supporti non inclusi.

~~€ 930,00~~

€ 651,00



**ANTE CON
DOPPIO
PANNELLO**



654 RV

Cod. U06540001

Armadio a tapparella scorrevole

- Pannelli forati interni.
- Tapparella in plastica a scorrimento orizzontale.
- Maniglia tapparella in metallo.
- Struttura in lamiera d'acciaio verniciata RAL 3020.
- Possibilità di ancoraggio a parete.
- Ganci e supporti non inclusi.

~~€ 810,00~~

€ 567,00



Banchi da lavoro



506 A2

Banco da lavoro con piano in acciaio

- Piano in lamiera d'acciaio zincata (spessore 2,5) con bordi anticaduta altezza 37 mm.
- Ripiano inferiore d'appoggio incluso.
- Predisposizione per il fissaggio al pavimento.
- Struttura in lamiera d'acciaio verniciata, colore nero RAL 9004.
- 4 montanti per le lunghezze 1 m e 1,5 m.
- 6 montanti per la lunghezza 2 m.
- Possibilità di montare il cassetto 506 U130.

CODICE	L (mm)	P (mm)	H (mm)		€ 235,00	€ 165,00
U05060011	1.000	700	850	50 kg	€ 333,00	€ 233,00
U05060012	1.500	700	850	63 kg	€ 416,00	€ 291,00



6
CASSETTI

506 A2C/2000

Cod. U05060033

Banco da lavoro con piano in acciaio

- Piano in lamiera d'acciaio zincata (spessore 2,5) con bordi anticaduta altezza 37 mm.
- Ripiano inferiore d'appoggio incluso.
- Predisposizione per il fissaggio al pavimento.
- Struttura in lamiera d'acciaio verniciata, colore nero RAL 9004.
- 6 montanti per la lunghezza 2 m.
- 2 cassetti con serratura montati su guide telescopiche, colore rosso RAL 3020.
- Dimensione interna cassetti: 570x420x175 mm.

~~€ 630,00~~

€ 441,00

		← 2.000
86 kg	mm	↑ 850
		↘ 700

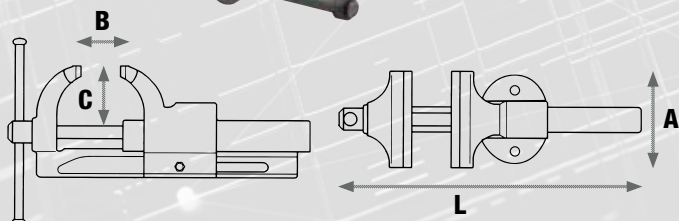

498 B

Morse parallele da banco

- Modello in acciaio interamente forgiato con ganasce e corpo in un solo pezzo.
- Ganasca posteriore con piano ad incudine.
- Doppia guida prismatica rettificata con viti per la regolazione del parallelismo delle ganasce ed il recupero dei giochi.
- Fornite con ganasce stringitubo.

CODICE	AXBXC	L	PESO	€ 216,00	€ 151,00
U04980012	100x125x74 mm	345 mm	6,9 kg	€ 257,00	€ 180,00
U04980013	125x150x83 mm	380 mm	10,7 kg	€ 348,00	€ 244,00
U04980014	150x200x94 mm	460 mm	18 kg	€ 459,00	€ 321,00



532

Baule portautensili (vuoto)

- Apertura ad arresto a 95°.
- Gancio per chiusura a lucchetto.
- Struttura in lamiera di acciaio, spessore 1,2 mm.

	CODICE	L (mm)	P (mm)	H (mm)			
A	U05320005	520	290	290	6,8 kg	€ 111,00	€ 77,70
B	U05320006	650	350	350	12,5 kg	€ 135,00	€ 94,00
C	U05320007	850	350	350	16 kg	€ 137,00	€ 96,00
D	U05320008	1000	400	450	19 kg	€ 179,00	€ 126,00



3
CASSETTI

531 A

Cod. U05310001

Cassettiera portatile (vuota)

- Dimensioni interne:
 - 2 cassetti 570x270x40 mm.
 - 1 cassetto 570x270x60 mm.

~~€ 245,00~~ € 172,00



5
SCOMPARTI

646/5LV

Cod. U06460301

Cassetta estensibile LUNGA (vuota)

- Predisposizione per lucchetto.
- Struttura in lamiera d'acciaio con verniciatura anaforetica.
- Versione lunga della cassetta 646/5V.
- Dimensioni interne:
 - vano 537x207x100 mm.
 - scomparti 537x103x52 mm.

~~€ 57,50~~ € 40,30



**MANIGLIE CASSETTI
IN ALLUMINIO**

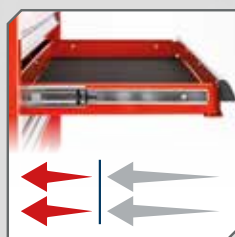

**GUIDE CON SISTEMA
DI RICHIAMO A
FINECORSA**



Anti corrosione



Resistente agli urti



Resistente alle alte e basse temperature



MAX
20 kg

001 RV

Cod. U00010004

Valigia porta utensili in polipropilene ad alto spessore (vuota)

- Due pannelli interni amovibili con elastici portautensili.
- Vano inferiore con divisori amovibili e regolabili.
- Doppia serratura con chiave.
- Maniglia ergonomica rivestita in gomma.
- 3 cerniere posteriori e doppio braccetto di tenuta coperchio in metallo.
- Gusci in polipropilene ad alto spessore montati su un'intelaiatura di alluminio.
- La struttura garantisce resistenza alle sostanze corrosive, alle basse ed alte temperature ed agli urti anche sugli angoli.

4,7 kg | 465 mm | 352 mm | 215 mm

~~€ 250,00~~

€ 175,00

6 kg | 465 mm | 352 mm | 255 mm



MAX
20 kg

001 TRV

Cod. U00010005

Valigia trolley porta utensili in polipropilene ad alto spessore (vuota)

- Maniglia telescopica in alluminio.
- Ruote con cuscinetto a sfera integrato.

~~€ 369,00~~

€ 258,00



641 T

Cassetta portautensili (vuota)

- In materiale plastico ad alta resistenza.
- 2 scomparti portaminuteria sul coperchio.
- Possibilità di chiusura con lucchetto (non fornito).
- Vassoio interno amovibile.



	CODICE	L (mm)	P (mm)	H (mm)	kg		
A	U06410004	16"	394	220	1,2	€ 19,30	€ 13,50
B	U06410005	19"	486	266	2,1	€ 28,90	€ 19,90
C	U06410006	24"	595	281	2,8	€ 38,50	€ 26,90



Sistema di apertura con una sola mano



Possibilità di chiusura con lucchetto (non fornito)



2 scomparti portaminuteria sul coperchio



Compatibile con
TSTAK™

STANLEY: FMST1-71968
DeWALT: DWST1-70705

900 g
mm
↔ 340
↑ 235
↙ 90

NEW

007 FTSV

Cod. U00070060

Borsa portautensili pieghevole (vuota)

- Tessuto ad altissima resistenza.
- 8 pratici e comodi vani portautensili.
- Pannello centrale con elastici portautensili in entrambi i lati.
- Asole porta martello.
- Maniglia superiore con rivestimento in gomma.
- Cinghia posteriore per fissare la borsa al trolley.
- Possibilità di essere utilizzata con tracolla (non inclusa).
- Codice tracolla: U00070001Q.

~~€ 30,00~~

€ 21,00



8 pratici vani
e 6 elastici portautensili



Cinghia posteriore
per fissare la borsa
al trolley

3,1 kg
mm
↔ 355
↑ 225
↙ 460



Tasca porta Notebook
o documenti



MAX
12 kg



CAPACITÀ
30 L

007 SV

Cod. U00070004

Zaino professionale portautensili (vuoto)

- Nylon ad altissima resistenza.
- Cinturino pettorale regolabile.
- Cinghie in vita imbottite.
- Base rigida resistente all'acqua.
- Vano interno portautensili.
- Portadocumenti interno.
- La tasca posteriore può contenere Notebook di dimensioni: L 340 mm - H 240 mm.

~~€ 79,50~~

€ 56,00



YouTube



Tasca frontale
porta seghetto



MAX
15 kg

007 V

Cod. U00070002

Borsa professionale porta utensili (vuota)

- Nylon ad altissima resistenza.
- Base rigida resistente all'acqua.
- Vani interni portautensili e tasca frontale porta seghetto.
- Maniglione in alluminio con impugnatura rivestita.
- Cinghia di trasporto a tracolla.
- Mantella di chiusura con velcro.

~~€ 84,50~~

€ 59,00

4 kg
mm
↔ 490
↑ 350
↙ 220

Valigia per manutenzione

NEW

181
PEZZI

002 JMA
Cod. U00020011

11 kg 460 mm 158 mm 385 mm

Valigia con assortimento per manutenzione

- Valigia con struttura in profilato di Alluminio.
- Doppia cerniera di chiusura in metallo con serratura.
- 3 pannelli portautensili interni con elastici di tenuta.
- Base con interno in mousse bicolore sagomata.

~~€ 615,00~~

€ 359,00



**CONTIENE LE PINZE SERIE AX,
I NUOVI GIRAVITI 324
E LA CHIAVE A RULLINO 294 AD!**

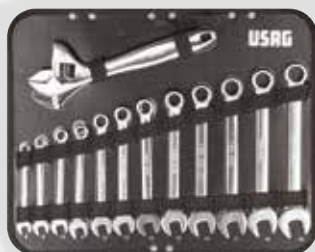

DESCRIZIONE	MISURA	PZ.
Chiavi a bussola 1/2" con bocca esagonale	10-11-12-13-14-15-16-17-18-19-21-22-24-27-30-32 mm	16
Chiavi a bussola 1/4" con bocca esagonale	4-4,5-5-5,5-6-7-8-9-10-11-12-13-14 mm	13
Prolunghe 1/2"	130-250 mm	2
Prolunghe 1/4"	55-100 mm	2
Cricchetto reversibile 1/2"		1
Cricchetto reversibile 1/4"		1
Impugnatura porta bussole 1/4"		1
Snodo cardanico 1/2"		1
Snodo cardanico 1/4"		1
Bussola portainseri	1/4-1/4"	1
Chiavi combinate	8-9-10-11-12-13-14-15-16-17-18-19 mm	12
Chiave a rullino	250 mm	1
Giraviti ad intaglio	0,4x2,5x50-0,5x3x75-0,8x4x100-1x5,5x125-1,2x6,5x150-1,6x8x175	6
Giraviti a croce PHILLIPS®	1x75-2x125	2
Giraviti a croce POZIDRIV-SUPADRIV®	1x75-2x125	2
Chiavi maschio esagonali	1,5-2-2,5-3-4-5-6-8-10 mm	9
Pinza universale	180 mm	1
Pinza regolabile	250 mm	1
Pinza a becchi mezzotondi	160 mm	1
Tronchese a taglio diagonale	160 mm	1

DESCRIZIONE	MISURA	PZ.
Giravite cercafase		1
Forbice da elettricista		1
Cutter multiuso		1
Flessometro	3 m	1
Mini seghetto		1
Martello da meccanico	300 g	1
Inseri ad intaglio	3-4-4,5-5-5,5-6-6,5-7-8	9
Inseri a croce PHILLIPS®	00-0-1(x2)-2(x2)-3-4	8
Inseri a croce POZIDRIV-SUPADRIV®	1-2(x2)-3-4	5
Inseri esagonali maschio	1,5-2-2,5-3-4-5-5,5-6-7-8 mm	10
Inseri esagonali maschio	1/16-5/64-3/32-7/64-1/8-9/64-5/32-3/16-7/32-1/4	10
Inseri TORX®	T8-T9-T10-T15-T20-T25-T27-T30-T40-T45	10
Inseri TORX® Tamper Resistant	T8-T10-T15-T20-T25-T27-T30-T35-T45	9
Inseri Tri-Wing	1-2-3-4	4
Inseri Spanner	4-6-8-10-12	5
Inseri Torq-set	6-8-10	3
Inseri quadrati	0-1-2(x2)-3	5
Inseri Clutch	1/8-5/32-3/16-1/4-5/16	5
Inseri per viti con impronta XZN	M5-M6-M8	3
Inseri esagonali maschio con foro	2-2,5-3-4-5-6	6
Inseri esagonali maschio con foro	5/64-3/32-7/64-1/8-9/64-5/32	6
Prolunghe magnetiche	1/4"	2



181
PEZZI

002 JTMA
Cod. U00020015

Valigia trolley con assortimento per manutenzione

- Valigia con struttura in profilato di Alluminio.
- Doppia cerniera di chiusura in metallo con serratura.
- 3 pannelli portautensili interni con elastici di tenuta.
- Base con interno in mousse bicolore sagomata.

~~€ 620,00~~

€ 379,00



**RUOTE INTEGRATE
NELLA STRUTTURA**

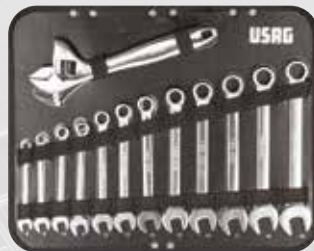

DESCRIZIONE	MISURA	PZ.
Chiavi a bussola 1/2" con bocca esagonale	10-11-12-13-14-15-16-17-18-19-21-22-24-27-30-32 mm	16
Chiavi a bussola 1/4" con bocca esagonale	4-4,5-5-5,5-6-7-8-9-10-11-12-13-14 mm	13
Prolunghe 1/2"	130-250 mm	2
Prolunghe 1/4"	55-100 mm	2
Cricchetto reversibile 1/2"		1
Cricchetto reversibile 1/4"		1
Impugnatura porta bussole 1/4"		1
Snodo cardanico 1/2"		1
Snodo cardanico 1/4"		1
Bussola portainseriti	1/4-1/4"	1
Chiavi combinate	8-9-10-11-12-13-14-15-16-17-18-19 mm	12
Chiave a rullino	250 mm	1
Giraviti ad intaglio	0,4x2,5x50-0,5x3x75-0,8x4x100-1x5,5x125-1,2x6,5x150-1,6x8x175	6
Giraviti a croce PHILLIPS®	1x75-2x125	2
Giraviti a croce POZIDRIV-SUPADRIV®	1x75-2x125	2
Chiavi maschio esagonali	1,5-2-2,5-3-4-5-6-8-10 mm	9
Pinza universale	180 mm	1
Pinza regolabile	250 mm	1
Pinza a becchi mezzotondi	160 mm	1
Tronchese a taglio diagonale	160 mm	1
Giravite cercafase		1

DESCRIZIONE	MISURA	PZ.
Forbice da elettricista		1
Cutter multiuso		1
Flessometro	3 m	1
Mini seghetto		1
Martello da meccanico	300 g	1
Inseriti ad intaglio	3-4-4,5-5-5,5-6-6,5-7-8	9
Inseriti a croce PHILLIPS®	00-0-1(x2)-2(x2)-3-4	8
Inseriti a croce POZIDRIV-SUPADRIV®	1-2(x2)-3-4	5
Inseriti esagonali maschio	1,5-2-2,5-3-4-5-5,5-6-7-8 mm	10
Inseriti esagonali maschio	1/16-5/64-3/32-7/64-1/8-9/64-5/32-3/16-7/32-1/4	10
Inseriti TORX®	T8-T9-T10-T15-T20-T25-T27-T30-T40-T45	10
Inseriti TORX® Tamper Resistant	T8-T10-T15-T20-T25-T27-T30-T35-T45	9
Inseriti Tri-Wing	1-2-3-4	4
Inseriti Spanner	4-6-8-10-12	5
Inseriti Torq-set	6-8-10	3
Inseriti quadrati	0-1-2(x2)-3	5
Inseriti Clutch	1/8-5/32-3/16-1/4-5/16	5
Inseriti per viti con impronta XZN	M5-M6-M8	3
Inseriti esagonali maschio con foro	2-2,5-3-4-5-6	6
Inseriti esagonali maschio con foro	5/64-3/32-7/64-1/8-9/64-5/32	6
Prolunghe magnetiche	1/4"	2



NUOVI GIRAVITI 324

Il giravite 324 si rinnova. Restano uguali le caratteristiche di progetto, migliorano materiali e finiture per renderlo il top della scelta sul mercato.



IMPUGNATURA TRIMATERIALE

Esterno in poliuretano resistente ad olii ed agenti chimici. Corpo in poliammide resistente agli sforzi. Interno in poliammide ad alta densità per un perfetto accoppiamento alla lama.

RIVESTIMENTO SOFT GRIP

Miglior comfort durante l'uso.
Maggior trasmissione della coppia.

LAMA RINFORZATA

Acciaio al cromo silicio vanadio per la massima resistenza meccanica.



GEOMETRIA ANTI-ROTOLAMENTO

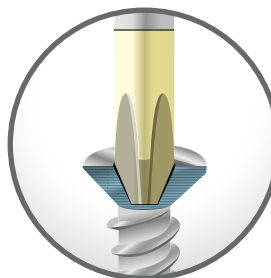

PUNTA AL TOP

Finitura zincata. Geometria perfetta. Trattamento anti corrosione.



8 PEZZI

324 SH8

Cod. U03240650



Serie di 8 giraviti per viti con intaglio e impronta a croce PHILLIPS®

- 324 D/0,4x2,5x50.
- 324/0,5x3x75-0,8x4x100-1x5,5x125-1,2x6,5x150.
- 324 PH/0x75-1x75-2x100.

€ 42,84

€ 27,50



12
PEZZI

324 SH12

Cod. U03240651



Serie di 12 giraviti per viti con intaglio, impronta a croce PHILLIPS® e impronta a croce POZIDRIV® - SUPADRIV®

- 324 D/0,4x2,5x50.
- 324/0,5x3x75-0,8x4x100-1x5,5x125-1,2x6,5x150.
- 324 N/1x5,5x35.
- 324 PH/0x75-1x75-2x100.
- 324 NPH/2x35.
- 324 PZ/1x75-2x100.



~~€ 72,49~~

€ 49,00



7
PEZZI

324 STX/S7

Cod. U03240662



Serie di 7 giraviti con impronta TORX® Tamper Resistant

- 324 STX T10x75-T15x75-T20x100-T25x100-T27x100-T30x125-T40x150.



~~€ 82,00~~

€ 57,00



4
PEZZI

324 PH/SE4

Cod. U03240668



Serie di 4 giraviti per viti con impronta a croce PHILLIPS®

- 324 PH/0x75-1x75-2x100-3x150.

~~€ 26,54~~

€ 18,50

NUOVI GIRAVITI ISOLATI 1000 V

NEW

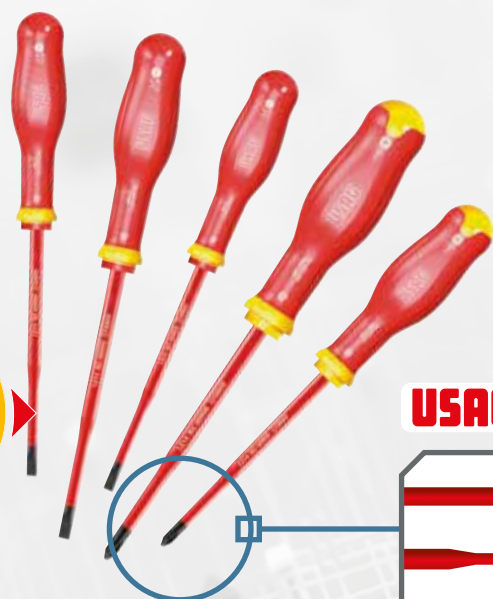

5
PEZZI

091 D/SH5

Cod. U00910119



Serie di 5 giraviti SLIM per viti con intaglio e per viti con impronta a croce PHILLIPS®

- 091 D/0,6x3,5x100-0,8x4x100-1x5,5x125.
- 091 DPH/1x100-2x125.

~~€ 48,47~~

€ 34,00



1000 V

NEW



5
PEZZI

091 SH5

Cod. U00910100



Serie di 5 giraviti per viti con intaglio e per viti con impronta a croce PHILLIPS®

- 091/0,5x3x75-0,8x4x100-1x5,5x125.
- 091 PH/1x100-2x125.

~~€ 39,89~~

€ 29,50



1000 V

NEW



8
PEZZI

091 SH8

Cod. U00910106



Serie di 8 giraviti per viti con intaglio, per viti con impronta a croce PHILLIPS® e impronta a croce POZIDRIV® - SUPADRIV®

- 091/0,5x3x75-0,8x4x100-1x5,5x125-1,2x6,5x150.
- 091 PH/1x100-2x125.
- 091 PZ/1x100-2x125.

~~€ 68,60~~

€ 48,00



1000 V

NUOVE PINZE ISOLATE 1000 V

NEW

**CERNIERA APERTA CON
ARTICOLAZIONE FORGIATA**

EN 60900



**TAGLIENTI TEMPRATI
AD INDUZIONE**

per la massima efficacia
nel taglio del filo dolce, di
media durezza e duro.

**IMPUGNATURE ERGONOMICHE
ISOLATE BIMATERIALE**

NEW



**2
PEZZI**

085 EX/SE2
Cod. U00850120



1000 V

**Assortimento con pinza universale e
tronchese a tagliente diagonale isolati 1000 V**

- 085 EX 180.
- 087 EX 160.

~~€ 71,20~~

€ 49,80

NEW



**3
PEZZI**

085 EX/SE3
Cod. U00850121



1000 V

**Assortimento con pinza universale, pinza
a becchi mezzotondi dritti e tronchese a
tagliente diagonale isolati 1000 V**

- 081 EX 160.
- 085 EX 180.
- 087 EX 160.

~~€ 109,10~~

€ 76,00

GAMMA PINZE "AX": IL TOP DELLE PERFORMANCE FINITURA CROMATA, IMPUGNATURE BIMATERIALE.

TAGLIENTI TEMPRATI AD INDUZIONE
per la massima efficacia nel taglio del filo armonico.



FULCRO PIÙ VICINO AI TAGLIENTI
per il minimo sforzo durante il taglio.

Taglia fino a \varnothing 2 mm di filo armonico
con il 30% in meno di forza
rispetto al valore massimo
indicato dalle normative europee
ISO5749 (tronchesi) - ISO5746 (pinze).



IMPUGNATURA
USAG

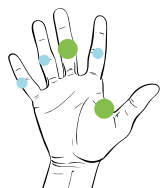

- SFORZO

PRODOTTI
SUL MERCATO

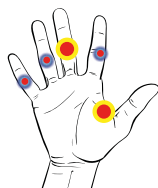

+ SFORZO

Minimo sforzo risultante
dagli studi
sugli sforzi muscolari
effettuati
dal prestigioso istituto
americano US Ergonomics.

**ASOLA
DI AGGANCIO**



YouTube

**IMPUGNATURE
ERGONOMICHE
BIMATERIALE**



**3
PEZZI**

150 AX/SE3

Cod. U01500201

Assortimento con pinza universale, pinza a becchi mezzotondi diritti e tronchesi a tagliente diagonale

- Pinza universale 150 AX 180.
- Pinza a becchi mezzotondi lunghissimi diritti 133 AX 160.
- Tronchese a grande effetto a tagliente diagonale 188 AX 160.

~~€ 81,00~~

€ 56,00



2
PEZZI

150 AX/SE2

Cod. U01500200

Assortimento con pinza universale e tronchese a tagliente diagonale

- Pinza universale 150 AX 180.
- Tronchese a grande effetto a tagliente diagonale 188 AX 160.

~~€ 53,00~~

€ 38,00



2
PEZZI

150 AX/SP2

Cod. U01500202

Assortimento con pinza universale e pinza regolabile

- Pinza universale 150 AX 180.
- Pinza regolabile a cerniera chiusa 180 C 250.

~~€ 55,80~~

€ 38,00



3
PEZZI

150 CX/SE3

Cod. U01500211

Assortimento con pinza universale, pinza a becchi mezzotondi diritti e tronchese a tagliente diagonale

- Pinza universale 150 CX 180.
- Pinza a becchi mezzotondi lunghissimi diritti 133 CX 160.
- Tronchese a grande effetto a tagliente diagonale 188 CX 160.

~~€ 68,00~~

€ 47,50

NUOVA PINZA UNIVERSALE MULTIFUNZIONE

TAGLIENTI TEMPRATI AD INDUZIONE
per la massima efficacia nel taglio del filo armonico.

FULCRO PIÙ VICINO AI TAGLIENTI
per il minimo sforzo durante il taglio.

**IMPUGNATURE ERGONOMICHE
BIMATERIALE**



YouTube

155 AX
Cod. U01550001

~~€ 50,00~~

€ 29,00

200 mm



PROFILI ESAGONALI

**GEOMETRIA DELLE
GANASCE STUDIATA PER
LA PRESA DI UN ESAGONO.**

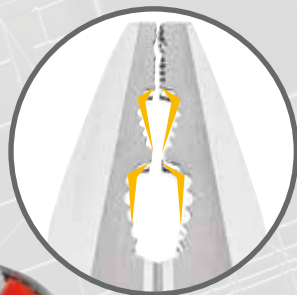

PROFILI TONDI

**INTAGLIO RICAVATO NELLA
DENTATURA PER UNA PRESA
SICURA DI BARRE TONDE,
ANCHE FILETTATE.**



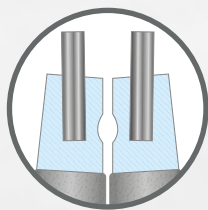

MASSIMA RESISTENZA

Punte in acciaio armonico inserite nei becchi.

NEW



4

PEZZI

127 N/SE4S

Cod. U01270046

Misure piccole



Serie 4 pinze per anelli elastici

- Pinze per anelli elastici interni
127 N 12÷25-127 PN 12÷25.
- Pinze per anelli elastici esterni
128 N 10÷25-128 PN 10÷25.

~~€ 81,60~~

€ 57,00

4

PEZZI

127 N/SE4

Cod. U01279000P

Misure grandi



Serie 4 pinze per anelli elastici

- Pinze per anelli elastici interni
127 N 19÷60-127 PN 19÷60.
- Pinze per anelli elastici esterni
128 N 19÷60-128 PN 19÷60.

~~€ 88,60~~

€ 62,00

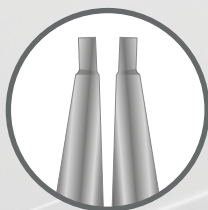

MASSIMA ACCESSIBILITÀ

Punte e becchi in corpo unico.

NEW

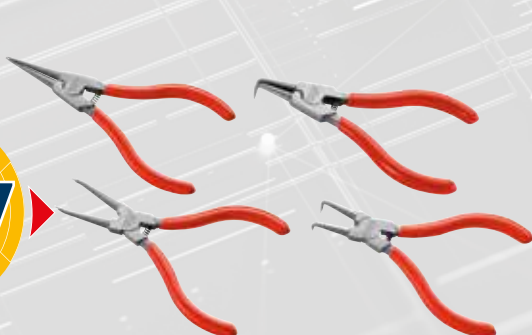

4

PEZZI

127 C/SE4S

Cod. U01270045

Misure piccole



Serie 4 pinze per anelli elastici

- Pinze per anelli elastici interni
127 C 12÷25-127 CP 12÷25.
- Pinze per anelli elastici esterni
128 C 10÷25-128 CP 10÷25.

~~€ 68,00~~

€ 47,00

4

PEZZI

127 C/SE4

Cod. U01270040

Misure grandi



Serie 4 pinze per anelli elastici

- Pinze per anelli elastici interni
127 C 19÷60-127 CP 19÷60.
- Pinze per anelli elastici esterni
128 C 19÷60-128 CP 19÷60.

~~€ 74,00~~

€ 52,00

Pinze regolabili



MAX Ø
50
mm

137

Cod. U01370001

Pinza regolabile autobloccante con ganasce a forcella

- Per la saldatura di tubi, lamiere e profilati.
- Ganasce in acciaio speciale altamente legato al Cromo Vanadio.
- Corpo in lamiera d'acciaio imbutita.
- Esecuzione nichelata.

~~€ 37,60~~

€ 26,00



MAX Ø
80
mm

135 A

Cod. U01350505

Pinza regolabile autobloccante a cremagliera con ganasce corte

- Ganasce forgiate.
- Dentatura studiata per una presa perfetta anche su tondo.
- Sistema di apertura brevettato ed integrato nei manici.
- Rullino di regolazione della presa integrato sul manico superiore.
- Cremagliera a 5 posizioni.

~~€ 59,50~~

€ 41,50

**SISTEMA DI APERTURA
INNOVATIVO BREVETTATO**



MAX Ø
200
mm

136 M

Cod. U01360511

Pinza regolabile autobloccante con ganasce superiore mobile

- Vite per la regolazione del parallelismo tra le ganasce.
- Ganasce in acciaio speciale altamente legato al Cromo Vanadio.
- Corpo in lamiera d'acciaio imbutita.
- Esecuzione nichelata.
- Accessori a richiesta: ganasce 136 MA e morsetto 136 MB.

~~€ 90,00~~

€ 63,00



MAX Ø
76
mm

139 AN

Cod. U01390004

Pinza regolabile autobloccante con ganasce a collo di cigno

- Per il bloccaggio di profilati ed angolari.
- Ganasce in acciaio speciale altamente legato al Cromo Vanadio.
- Corpo in lamiera d'acciaio imbutita.
- Esecuzione nichelata.

~~€ 29,70~~

€ 21,00

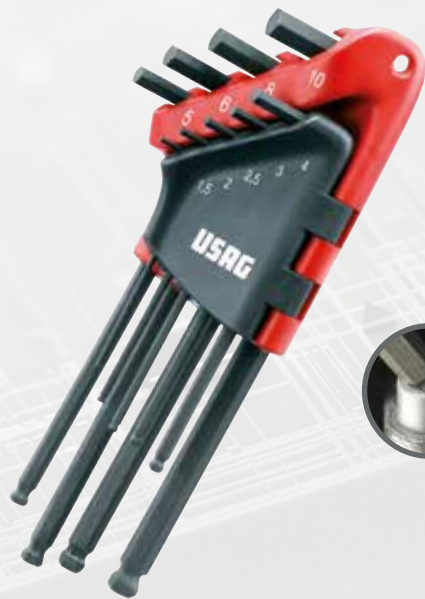

9
PEZZI

280 LTS/S9



Cod. U02800084

Serie di 9 chiavi maschio esagonale lunghe testa sferica

- 280 LTS/1,5-2-2,5-3-4-5-6-8-10 mm.

~~€ 29,00~~

€ 18,20



8
PEZZI

280 LTSTX/S8



Cod. U02800078

Serie di 8 chiavi maschio lunghe testa sferica TORX®

- 280 LTSTX/T10-T15-T20-T25-T27-T30-T40-T45.

~~€ 52,50~~

€ 36,80



9
PEZZI

280 XLTS/S9



Cod. U02800184

Serie di 9 chiavi maschio esagonale extra-lunghe a testa sferica

- 280 XLTS/1,5-2-2,5-3-4-5-6-8-10 mm.

~~€ 32,04~~

€ 23,00



SUPPORTI COMPATTI CON SISTEMA DI ESTRAZIONE RAPIDA



Estrazione della singola chiave senza muovere le altre.



I denti d'aggancio garantiscono la tenuta delle chiavi nel supporto.



Il foro permette di appendere il supporto.

MODELLO EXTRA LUNGO +30% RISPETTO ALLE 280 LTS

280 T CHIAVE A T CON MASCHIO ESAGONALE



ACCIAIO SPECIALE
al cromo vanadio.

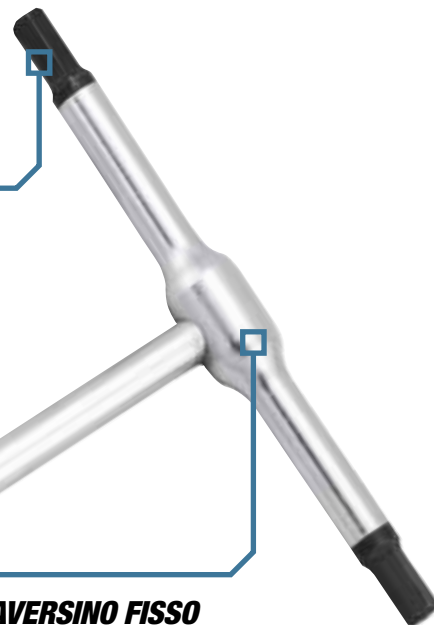

TRAVERSINO FISSO
Massima resistenza.

USAG 280T/5



CHIAVI USAG



ALTRE CHIAVI

SICUREZZA GARANTITA

- +30% resistenza alla torsione rispetto alla norma ISO 2936.
- Raggiunta la coppia di rottura, la chiave si deforma senza spezzarsi.

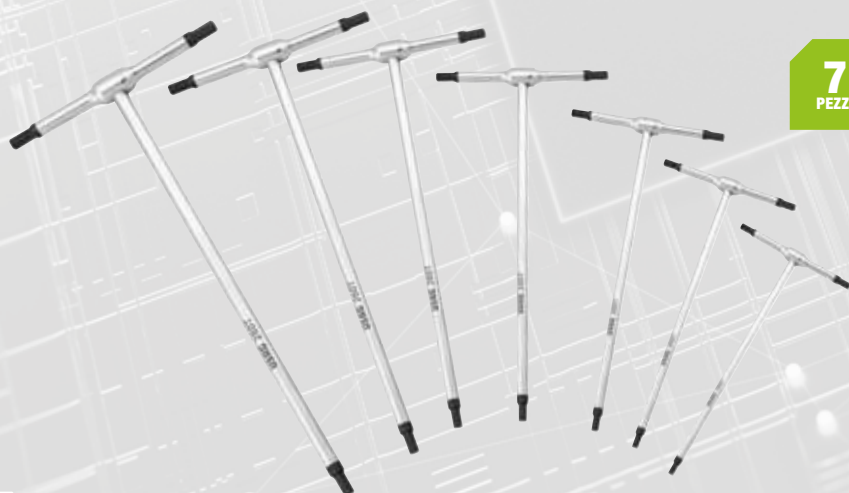

7
PEZZI

280 T/SE7



Cod. U02800903

Serie di 7 chiavi a T con maschio esagonale

- 280 T/2,5-3-4-5-6-8 mm.
- Per viti con esagono incassato.
- Acciaio speciale altamente legato al cromo vanadio.
- Esecuzione cromata con estremità brunate per garantire la precisione dimensionale ed il perfetto accompagnamento della vite.

~~€ 102,20~~

€ 71,50

TESTA SFERICA



6
PEZZI

280 TTS/SE6

Cod. U02800760



Serie di 6 chiavi a T maschio esagonali con testa sferica

- 280 TTS/2,5-3-4-5-6-8 mm.
- Per viti con esagono incassato.
- Acciaio speciale altamente legato al cromo vanadio.
- Esecuzione cromata con estremità brunate.
- Modello che permette di operare con inclinazioni fino a 30° rispetto all'asse della vite.
- Massima accessibilità con la testa sferica.

~~€ 89,70~~

€ 62,80

TESTA SFERICA



4
PEZZI

280 TSTX/SE4

Cod. U02800790



Serie di 4 chiavi a T con impronta TORX® a testa sferica

- 280 TSTX/T15-T20-T25-T30.
- Acciaio speciale altamente legato al cromo vanadio.
- Esecuzione cromata con estremità brunate.
- Modello che permette di operare con inclinazioni fino a 30° rispetto all'asse della vite.
- Massima accessibilità con la testa sferica.

~~€ 74,80~~

€ 52,50

TRAVERSINO SCORREVOLE

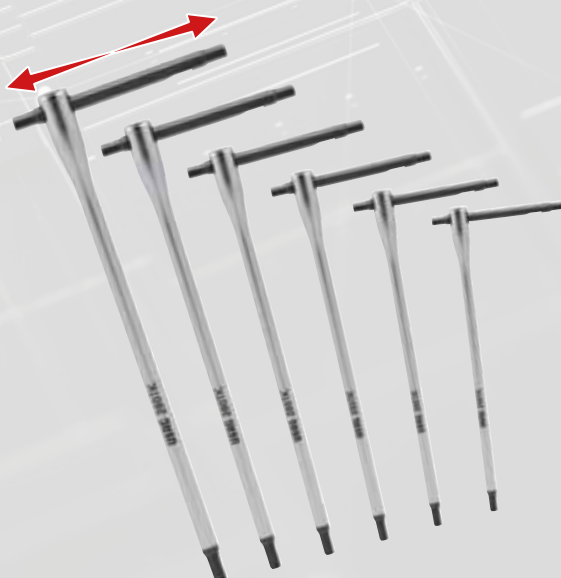

6
PEZZI

280 TK/SE6

Cod. U02800020



Serie di 6 chiavi a T maschio esagonale con traversino scorrevole

- 280 TK/2,5-3-4-5-6-8 mm.
- Per viti con esagono incassato.
- Traversino scorrevole che permette di avere maggiore accessibilità rispetto alla chiave standard.
- Fermo di sicurezza che impedisce l'estrazione del traversino.
- Acciaio speciale altamente legato al cromo vanadio.
- Esecuzione cromata con estremità brunate per il gambo.
- Esecuzione interamente brunita per il traversino.
- Estremità dimensionate per il perfetto accoppiamento con la vite.

~~€ 90,60~~

€ 60,00

ISO 6789

1/2"



YouTube



PRECISIONE
±4%

810 F

Chiave dinamometrica con cricchetto reversibile a testa snodata

- Testa snodata per agevolarne l'utilizzo in spazi ridotti o profondi.
- Angolo di inclinazione fino a 20°.
- Scala di lettura in Nm.
- Modello a coppia regolabile per serraggi destrorsi.
- Riarmo automatico al rilascio dopo il disinnesto.
- Fornita con certificato di collaudo.

ARTICOLO	CODICE	CAPACITÀ	☑	L (mm)	RISOL.	€	€
810 F 100	U08104013	20 ÷ 100	1/2"	447	0,25	€ 207,00	€ 135,00
810 F 200	U08104015	40 ÷ 200	1/2"	500	0,5	€ 207,00	€ 135,00

⚠ IMPORTANTE ⚠

Quando la chiave è utilizzata inclinata a +/- 20° la coppia di serraggio deve essere impostata con un incremento del +5%.
Esempio: Coppia necessaria 90 Nm = Coppia per uso inclinato 94,5 Nm.

ISO 6789

1/4"

3/8"

1/2"



PRECISIONE
±4%

810 N

Chiave dinamometrica con cricchetto reversibile

- Modello a coppia regolabile per serraggi destrorsi.
- Riarmo automatico al rilascio dopo il disinnesto.
- Fornita con certificato di collaudo.

ARTICOLO	CODICE	CAPACITÀ	☑	L (mm)	RISOL.	€	€
810 N 5	U08104000	1 ÷ 5	1/4"	197	0,05	€ 194,00	€ 125,00
810 N 25	U08104001	5 ÷ 25	1/4"	290	0,05	€ 198,00	€ 125,00
810 N 50	U08104002	10 ÷ 50	3/8"	350	0,25	€ 198,00	€ 125,00
810 N 100	U08104003	20 ÷ 100	1/2"	410	0,25	€ 198,00	€ 125,00
810 N 200	U08104005	40 ÷ 200	1/2"	475	0,5	€ 200,00	€ 125,00
810 N 340	U08104006	68 ÷ 340	1/2"	630	1	€ 229,00	€ 149,00

ISO 6789

3/4"

PRECISIONE
±4%

812 N

Chiavi dinamometriche con cricchetto reversibile

- **812 N 600:** Modello a coppia regolabile per serraggi destrorsi e sinistrorsi con rotazione del cricchetto di 180°.
- **812 N 1000:** Modello a coppia regolabile per serraggi destrorsi.
- Precisione ±4% del valore di coppia impostato.
- Scala di lettura in Nm.
- Segnale sensitivo e sonoro al raggiungimento della coppia impostata.
- Riarmo automatico al rilascio dopo il disinnesto.
- Blocco di sicurezza dopo la regolazione della coppia.
- Fornita in cassetta di lamiera completa di certificato di collaudo.
- Cricchetto con attacco quadro 3/4"

ARTICOLO	CODICE	CAPACITÀ	☑	€	€
812 N 600	U08120006	120 ÷ 600	3/4"	€ 911,00	€ 629,00
812 N 1000	U08120010	200 ÷ 1000	3/4"	€ 1.140,00	€ 789,00

Serraggi controllati utilizzando cricchetti o chiavi a T



YouTube



1/2"

814 A

Dispositivo digitale coppia-angolo

- Permette serraggi coppia ed angolo di precisione digitale anche con utensili tradizionali.
- Per serraggi destrorsi e sinistrorsi.
- Scala di lettura in Nm/ft.lb/in-lb/kg.cm/gradi.
- Doppia indicazione: luminosa (LED) e sonora (buzzer) al raggiungimento del valore impostato.
- 9 valori di coppia o angolo preimpostabili.
- 50 misurazioni memorizzabili.
- In custodia di ABS con certificato di taratura.
- Alimentazione: 2 batterie AAA (include).

CODICE	CAPACITÀ	1/2"	RISOL.	€ 228,00	€ 159,00
U08140003	6,8 - 135	1/2"	0,1	€ 228,00	€ 159,00
U08140004	10 - 200	1/2"	0,1	€ 262,00	€ 183,00
U08140005	17 - 340	1/2"	0,1	€ 318,00	€ 222,00



UNI-EN 26789

PRECISIONE
±6%

1/4"

824 A

Giraviti dinamometrici

- Modello a coppia regolabile per serraggi destrorsi da utilizzare in abbinamento agli inserti della serie 660 o, tramite raccordo, alle chiavi a bussola della serie mano da 1/4".
- Scala di lettura in Nm.
- Disinnesto automatico al raggiungimento della coppia impostata.
- Riarmo automatico dopo 120°.
- Fornito con chiave di regolazione e certificato di collaudo.

CODICE	CAPACITÀ	L (MM)	RISOL.	€ 219,00	€ 135,00
U08240004	0,5÷2,5	145	0,1	€ 219,00	€ 135,00
U08240006	2÷10	167	0,5	€ 223,00	€ 135,00



KIT UNIVERSALE

23
PEZZI

824 SK23

Cod. U08240007



Kit universale per sostituzione inserti da taglio

- Permette di sostituire gli inserti da taglio utilizzati sugli utensili rotanti delle frese.

DESCRIZIONE	ART/MISURA	PZ.
Giravite dinamometrico	824 A 0,5÷2,5 Nm	1
Giravite dinamometrico	824 A 1,4÷10 Nm	1
Inserti esagono maschio	664 EL 2-3-4-5	4
Inserti TORX®	664 TX 6-7-8-9-10-15-20-25	8
Inserti TORX PLUS®	664 IP 6-7-8-9-10-15-20-25	8
Portainseri magnetico	672 AMG	1

€ 415,00

€ 290,00



ATTENZIONE

Rispettare le corrette coppie di serraggio evita qualunque tipo di danneggiamento dell'inserto o della vite.



YouTube

2 kg
mm
435
70
270

ESTRATTORI 458 E PER VITI ESAGONALI DANNEGGIATE



9
PEZZI

458 E/B9
Cod. U04580313

Set di estrattori per viti esagonali danneggiate

- Profilo speciale esclusivo.
- Permettono di svitare viti esagonali anche molto danneggiate.
- In acciaio speciale con finitura fosfatata.
- Attacco esagonale da 1/4".
- Inclusa bussola portainseri 1/4-1/4".
- Fornito in astuccio di tessuto compatto.

2-2,5-3-4-5-
6-7-8 mm



1/4 Bussola
portainseri

DESCRIZIONE	ART./MISURA	PZ.
Estrattori per viti esagonali danneggiate 458 E 2-2,5-3-4-5-6-7-8		8
Bussola portainseri	684 1/4	1

~~€ 42,70~~

€ 29,90

EFFICACE ANCHE SU VITI MOLTO DANNEGGIATE





1/4

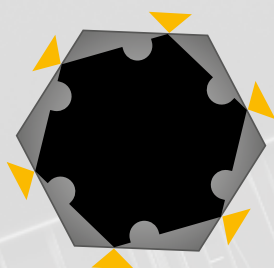

PROFILO ESCLUSIVO

Lo speciale design con cui sono realizzati gli inserti, permette di fare presa sugli esagoni incassati in qualunque condizione: intatti o completamente danneggiati.



 YouTube

VITI DANNEGGIATE

Quando una vite con esagono incassato si danneggia, non è più possibile svitarla con normali chiavi maschio esagonali. I nuovi estrattori 458 E permettono di svitare anche viti danneggiate fino al 98% del profilo esagonale.





20
PEZZI

458 S20

Cod. U04580312

Assortimento di estrattori per viti e dadi esagonali danneggiati

- Composto da estrattori per profili esagonali esterni o incassati.
- Permettono di svitare viti e dadi esagonali anche molto danneggiati.
- In acciaio speciale con finitura fosfatata.
- 458 B: bussole con attacco 3/8 o 1/2" e profilo elicoidale conico.
- 458 E: inserti con attacco 1/4" e profilo speciale esclusivo.
- Inclusa bussola portainseriti 1/4-1/4".
- Cassetta in ABS ad alta resistenza.
- Modulo interno in spugna bicolore.

DESCRIZIONE	ART./MISURA	PZ.
Estrattori per viti e dadi esagonali danneggiati	458 B 8-10-11-12-13-14-15-16-17-18-19	11
Estrattori per viti esagonali danneggiati	458 E 2-2,5-3-4-5-6-7-8	8
Bussola portainseriti	684 1/4	1

~~€ 170,00~~

€ 119,00

NEW

KIT COMPLETO PER VITI E DADI DANNEGGIATI



PROFILO ESCLUSIVO PER ESAGONI INCASSATI

Lo speciale design degli inserti permette di fare presa su esagoni incassati intatti o completamente danneggiati.

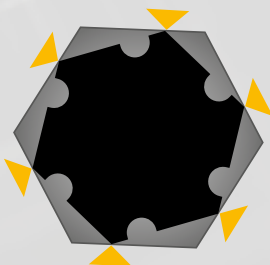

**2-2,5-3-4-5-
6-7-8 mm**



PROFILO ELICOIDALE PER DADI E VITI ESAGONALI

Le bussole elicoidali coniche garantiscono una presa esterna efficace su esagoni danneggiati.

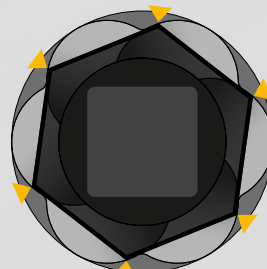

**8-10-11-12-13-
14-15-16-17-
18-19 mm**

285 CHIAVE COMBINATA



FORCHETTA INCLINATA

Angolo di 15° rispetto all'asse della chiave.



YouTube

SEZIONE A DOPPIA T

Massima resistenza alla flessione.

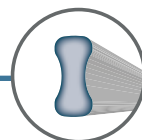

OCCHIO DISASSATO

Per dadi e bulloni incassati in posizioni di difficile accesso.



TOP PERFORMANCE

Resistenza alla torsione statica di anello e forchetta: **+50% rispetto alla norma ISO 1711-1.**

ISO 1711-1
SAE AS 954E



8
PEZZI

285 DS8

Cod. U02850863

Serie di 8 chiavi combinate

- 285/8-10-11-12-13-14-17-19 mm.
- Fornita con supporto in plastica.

~~€ 69,50~~

€ 45,00



26
PEZZI

285 SE26

Cod. U02850861

Serie di 26 chiavi combinate

- 285/6-7-8-9-10-11-12-13-14-15-16-17-18-19-20-21-22-23-24-25-26-27-28-29-30-32 mm.

~~€ 302,00~~

€ 211,00

285 KA

CHIAVE COMBINATA A CRICCHETTO CON ANELLO DI TENUTA

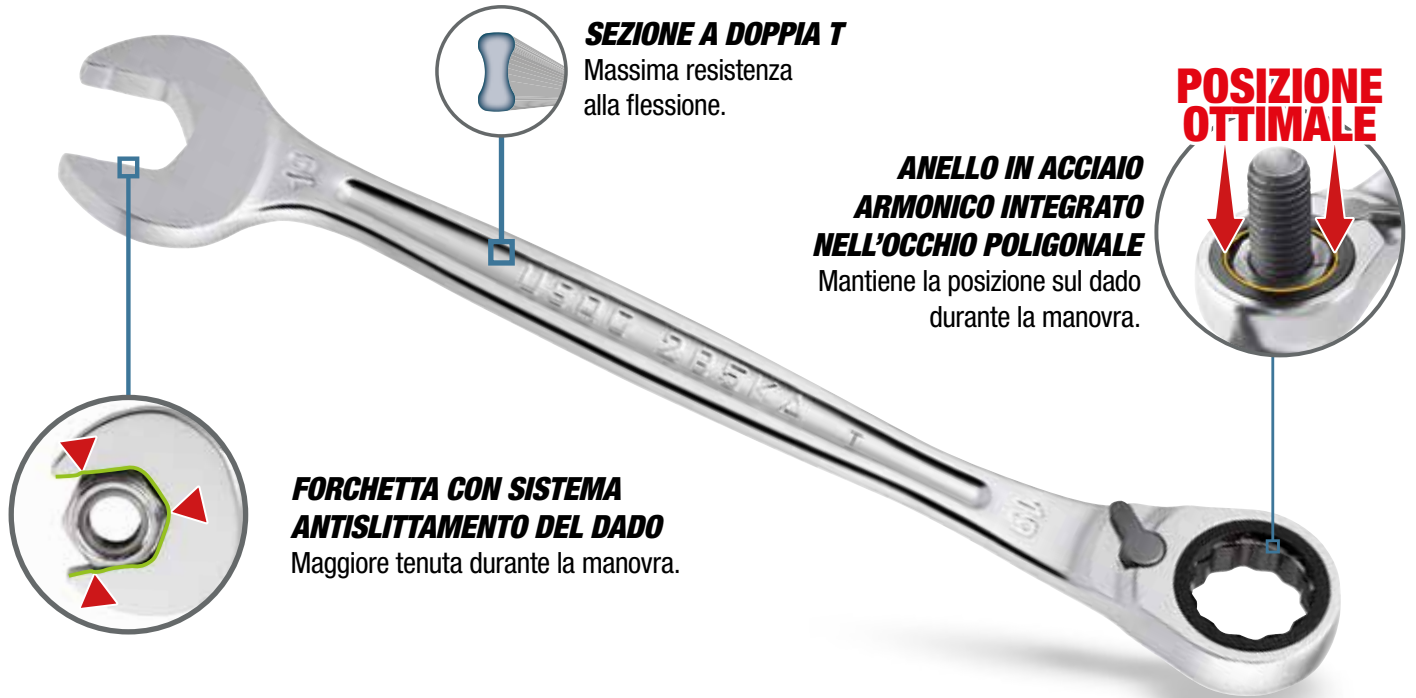

SEZIONE A DOPPIA T

Massima resistenza alla flessione.

POSIZIONE OTTIMALE

ANELLO IN ACCIAIO ARMONICO INTEGRATO NELL'OCCHIO POLIGONALE

Mantiene la posizione sul dado durante la manovra.

FORCHETTA CON SISTEMA ANTISLITTAMENTO DEL DADO

Maggiore tenuta durante la manovra.



CRICCHETTO RESISTENTE

Resistenza alla torsione statica del cricchetto: +50% rispetto alla norma ISO 1711-1.



YouTube

8÷19 mm



7÷19 mm



8 PEZZI

285 KA/DS8

Cod. U02856058

Serie di 8 chiavi combinate a cricchetto con anello di tenuta

- 285 KA/8-10-11-12-13-14-17-19 mm.

€ 140,00

€ 93,00

12 PEZZI

285 KA/DS12

Cod. U02856062

Serie di 12 chiavi combinate a cricchetto con anello di tenuta

- 285 KA/7-8-10-11-12-13-14-15-16-17-18-19 mm.

€ 212,00

€ 149,00

Chiavi di manovra



6÷22 mm

8
PEZZI

252 N/SR8

Cod. U02520862

Serie di 8 chiavi a forchetta doppie

- 252 N/6x7-8x9-10x11-12x13-14x15-16x17-18x19-20x22 mm.

~~€ 51,32~~

€ 36,00



8÷19 mm



TESTA SNODATA

8
PEZZI

285 KF/DS8

Cod. U02856158

Serie di 8 chiavi combinate a cricchetto snodate

- 285 KF/8-10-11-12-13-14-17-19 mm.

~~€ 166,70~~

€ 115,00



8÷19 mm



CAMBIO DEL SENSO DI ROTAZIONE

8
PEZZI

285 KB/SR8

Cod. U02856339

Serie di 8 chiavi combinate a cricchetto piatte

- 285 KB/8-10-12-13-14-15-17-19 mm.

~~€ 107,94~~

€ 76,00

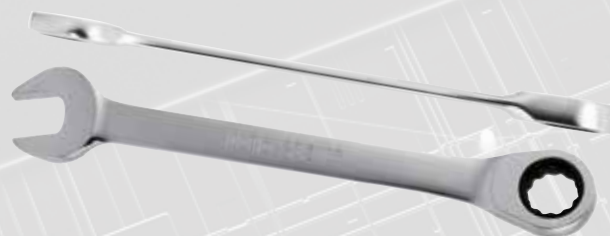

8÷19 mm



5
PEZZI

291 N/SE5

Cod. U02910280



Serie di 5 chiavi a pipa doppie pesanti

- 291 N/8-10-13-17-19 mm.

~~€ 46,70~~

€ 56,00

NEW



7÷13 mm

4
PEZZI

299 SE4

Cod. U02990200



Serie di 4 chiavi a bussola esagonale con impugnatura

- 299/7-8-10-13 mm.

~~€ 60,30~~

€ 42,00

7÷19 mm

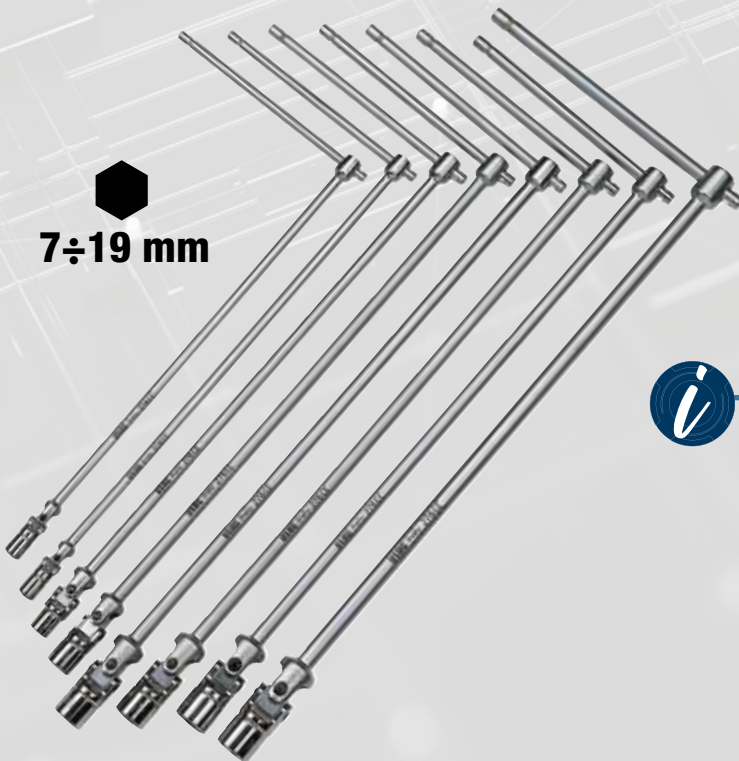

8
PEZZI

276 CE/SE8

Cod. U02760484



Serie di 8 chiavi a T snodate

- 276 CE/7-8-10-12-13-14-17-19 mm.

~~€ 228,90~~

€ 160,00



LO SNODO CARDANICO USAG

- Molla di frizione interna per il perfetto preposizionamento della bussola.
- Bussola e cardano fissati con un perno in acciaio ribadito per la massima affidabilità.
- Chiavi progettate e prodotte rispettando la normativa UNI 6743.



294 AD CHIAVE A RULLINO CON REGOLAZIONE RAPIDA



**APERTURA
MAGGIORATA
+20%**

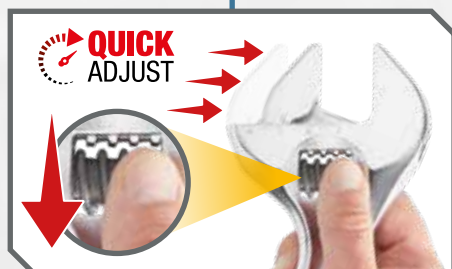

**ARRETRI IL RULLINO,
REGOLI RAPIDAMENTE.**

**RUOTI IL RULLINO,
REGOLI CON PRECISIONE.**



YouTube

294 AD

Chiavi a rullino con regolazione rapida

- Si regola rapidamente arretrando il rullino.
- Grande capacità: apertura +20% rispetto allo standard.
- Doppia scala graduata: millimetri e pollici.
- Testa inclinata di 22°.
- Rullino in acciaio.
- Asola di aggancio.
- Finitura cromata.

CODICE	L	APERTURA		
U02940011	110 mm - 4"	17 mm	€ 16,50	€ 11,60
U02940012	150 mm - 6"	23 mm	€ 17,30	€ 12,10
U02940013	200 mm - 8"	33 mm	€ 20,70	€ 14,50
U02940014	250 mm - 10"	38 mm	€ 26,30	€ 18,40
U02940015	300 mm - 12"	41 mm	€ 34,60	€ 24,20
U02940016	380 mm - 15"	50 mm	€ 63,50	€ 44,50
U02940017	460 mm - 18"	63 mm	€ 104,00	€ 72,80

294 AG CHIAVE A RULLINO REVERSIBILE



**APERTURA
MAGGIORATA
+20%**

**POSIZIONE
STANDARD**

**GANASCIA
INVERTITA**

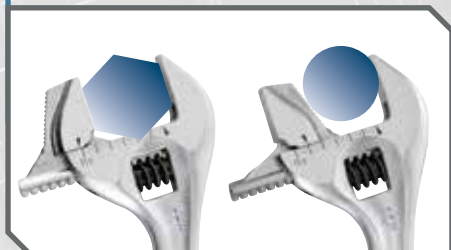

INVERTI LA GANASCIA MOBILE
per passare dalla presa su esagono
a quella su tondo.



YouTube

294 AG

Chiavi a rullino reversibili con impugnatura

- Nella posizione standard può manovrare un profilo esagonale.
- Invertendo il dente mobile, può manovrare un profilo tondo.
- Grande capacità: apertura +20% rispetto allo standard.
- Doppia scala graduata: millimetri e pollici.
- Impugnatura ergonomica bimateriale.
- Testa inclinata di 22°.
- Rullino in acciaio.
- Asola di aggancio.
- Finitura cromata.

CODICE	L	APERTURA		
U02940023	200 mm - 8"	33 mm	€ 22,70	€ 15,90
U02940024	250 mm - 10"	38 mm	€ 28,90	€ 20,20
U02940025	300 mm - 12"	41 mm	€ 38,00	€ 26,60

237 AK

CRICCHETTO CON IMPUGNATURA ROTANTE

NEW



PULSANTE DI RILASCIO DELLA BUSSOLA



GHIERA PER L'INVERSIONE DELLA MANOVRA



DOPPIO UTILIZZO



TRADIZIONALE



IMPUGNATURA ROTANTE

RIVESTIMENTO SOFT GRIP
Miglior comfort durante l'uso.
Maggior trasmissione della coppia.



1/4"

237 1/4" AK
Cod. U02370003

Cricchetto reversibile 1/4"
con impugnatura rotante

~~€ 45,10~~

€ 31,50



1/2"

237 1/2" AK
Cod. U02370009

Cricchetto reversibile 1/2"
con impugnatura rotante

~~€ 74,00~~

€ 52,00

237 A

CRICCHETTO REVERSIBILE CON MECCANISMO SIGILLATO IP51



Sistema di inversione integrato nel coperchio

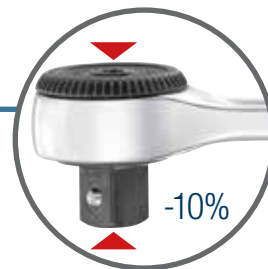

Spessore della testa ridotto rispetto ai modelli standard -10%

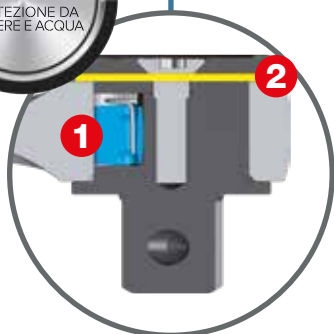

1. Nottolino brevettato.
2. Diaframma protettivo.



YouTube



IMPUGNATURA CONICA
in bimateriale e antiscivolo.

TOP PERFORMANCE

1. Resistenza alla torsione statica: **+30% di coppia rispetto alla norma ISO 3315 grazie al nottolino brevettato.**
2. Resistenza a fatica: **dura il doppio dei normali cricchetti del mercato grazie alla protezione IP51.**



23
PEZZI

606 1/2" EA 
Cod. U06060302

1/2"

Assortimento in cassetta di ABS con bussole esagonali

- Cassetta in ABS ad alta resistenza con sistema di chiusura rapida.



DESCRIZIONE	ART./MISURA	PZ.
Chiavi a bussola con bocca esagonale	235 1/2 EN 8-9-10-11-12-13-14-15-16-17-18-19-21-22-23-24-27-30-32	19
Prolunghe	236 1/2 125-250	2
Snodo cardanico	241 1/2	1
Cricchetto reversibile certificato IP51	237 A 1/2	1

€ 211,43

€ 129,00





19
PEZZI

606 1/4" EA



Cod. U06060101

1/4"

Assortimento in cassetta di ABS con bussole esagonali

- Cassetta in ABS ad alta resistenza con sistema di chiusura rapida.



DESCRIZIONE	ART./MISURA	PZ.
Chiavi a bussola con bocca esagonale	235 1/4 EN 4-4,5-5-5,5-6-7-8-9-10-11-12-13-14	13
Prolunghe	236 1/4 50-100	2
Snodo cardanico	241 1/4	1
Leva a T con attacco quadro scorrevole	240 1/4	1
Portabussole con impugnatura	243 1/4	1
Cricchetto reversibile certificato IP51	237 A 1/4	1

1 kg | mm | 210
60
130

~~€ 109,33~~

€ 69,00

BUSSOLE IN MILLIMETRI E POLLICI



NEW

35
PEZZI

612 1/2" MPA



Cod. U06122014

1/2"

Assortimento in cassetta di lamiera con bussole poligonali

DESCRIZIONE	ART./MISURA	PZ.
Chiavi a bussola con bocca poligonale	235 1/2 N 10-11-12-13-14-15-16-17-18-19-22-24-27-30-32	15
Chiavi a bussola in pollici con bocca poligonale	235 1/2 PN 3/8-7/16-1/2-9/16-5/8-11/16-3/4-13/16-7/8-15/16-1-1 1/16-1 1/8-1 3/16-1 1/4	15
Prolunghe	236 1/2 125-250	2
Snodo cardanico	241 1/2	1
Leva a T scorrevole	240 1/2 N	1
Cricchetto reversibile certificato IP51	237 A 1/2	1



7,5 kg | mm | 425
83
395

~~€ 365,99~~

€ 256,00



NEW

17
PEZZI

612 3/4" EB



Cod. U06120017

3/4"

Assortimento in cassetta di lamiera con bussole esagonali

DESCRIZIONE	ART./MISURA	PZ.
Chiavi a bussola con bocca esagonale	235 3/4 N 22-23-24-26-27-28-30-32-36-38-41-46-50	13
Prolunghe	236 3/4 200-400	2
Leva a T scorrevole	240 3/4 N	1
Cricchetto reversibile con meccanismo sigillato 120 denti	237 B 3/4	1



13 kg | mm | 425
83
395

~~€ 492,50~~

€ 345,00

Cassette di bussole



**COMPATTA
STA IN TASCA!**



YouTube



900 g 155 mm 50 mm 95°

**38
PEZZI**

609 1/4" EB

Cod. U06090002



Assortimento con bussole esagonali ed inserti per avvitatura

- Cassette compatta in bimatereale con rivestimento soft-touch.

DESCRIZIONE	ART./MISURA	PZ.
Bussole esagonali	235 1/4" EN 5,5-6-7-8-9-10-11-12-13-14 mm	10
Prolunghe	236 1/4" 50-100	2
Cricchetto reversibile	237 B 1/4"	1
Snodo cardanico	241 1/4"	1
Impugnatura porta-bussola	243 1/4"	1
Inserti ad intaglio	660 0,6x4,5-1x5,5-1,2x6,5	3
Inserti PH	660 PH 1-2-3	3
Inserti PZ	660 PZ 1-2-3	3
Inserti esagonali	660 E 2-3-4-5-6	5
Inserti TORX®	660 STX T10-T15-T20-	7
Tamper Resistant	T25-T27-T30-T40	
Inserto porta-bussola	660 Q 1/4"	1
Bussola porta-inserti	684 1/4"-1/4"	1

~~€ 179,46~~

€ 125,00



2,5 kg 435 mm 70 mm 270°

**44
PEZZI**

607 1/4" EB

Cod. U06070104



Assortimento in cassetta di ABS con bussole esagonali

- Cassette in ABS ad alta resistenza con sistema di chiusura rapida.

DESCRIZIONE	ART./MISURA	PZ.
Bussole esagonali lunghe	235 1/4" EL 5-6-7-8-9-10-11-12-13-14 mm	10
Bussole esagonali	235 1/4" EN 4-4,5-5-5,5-6-7-8-9-10-11-12-13-14 mm	13
Prolunghe	236 1/4" 50-100-150	3
Prolunga flessibile	236 1/4" SN	1
Cricchetto reversibile	237 B 1/4"	1
Leva a T	240 1/4"	1
Snodo cardanico	241 1/4"	1
Impugnatura porta-bussola	243 1/4"	1
Inserti ad intaglio	660 0,6x4,5-0,8x5,5-1x5,5-1,2x6,5	4
Inserti esagonali	660 E 2,5-3-4-5-6	5
Inserti PH	660 PH 1-2-3	3
Bussola porta-inserti	684 1/4"-1/4"	1

~~€ 262,93~~

€ 184,00



Inserto portabussole



350 g | 120 mm | 35 mm | 65



YouTube

31 PEZZI

1/4"

606 1/4" SK

Cod. U06060012



Assortimento inserti con cricchetto reversibile

DESCRIZIONE	PZ.	ART./MISURA
Cricchetto reversibile	1	237 1/4" SFK
Inserti ad intaglio	2	660 0,5x4-1x5,5
Inserti esagonali	9	660 E 1,5-2-2,5-3-4-5-6-7-8
Inserti a croce PHILLIPS®	3	660 PH 1-2-3
Inserti a croce POZIDRIV®- SUPADRIV®	3	660 PZ 1-2-3
Raccordo portainseriti	1	660 Q 1/4"
Inserti TORX® Tamper Resistant	7	660 STX T10-T15-T20-T25-T27-T30-T40
Inserti TORX®	4	660 TX T6-T7-T8-T9
Prolunga magnetica	1	672 1/4" MG 100

~~€ 62,00~~

€ 44,00



265 g | 120 mm | 35 mm | 65

11 PEZZI

1/4"

610 1/4" EFK

Cod. U06100001

Assortimento bussole ribassate con cricchetto reversibile

~~€ 81,50~~

€ 54,00

5,5-6-7-8-9-10-11-12-13-14 mm

BUSSOLE ESAGONALI RIBASSATE

Garantiscono il doppio dell'accessibilità rispetto all'utilizzo di un cricchetto standard.



-50%



YouTube

Cassette di bussole

YouTube



Just **USAG**



100
PEZZI

601 1/4-1/2 J100

Cod. U06010011



1/2"

Assortimento in cassetta modulare con bussole esagonali ed inserti per avvitatura

1/4"

~~€ 175,00~~

€ 115,00

8 kg 415 mm 92 mm 283 mm



MODULARE CON I CASSETTI DEI CARRELLI USAG!



DESCRIZIONE	MISURA	PZ.
Chiavi a bussola 1/4" con bocca esagonale	4-4,5-5,5-6-7-8-9-10-11-12-13-14 mm	12
Chiavi a bussola 1/4" lunghe con bocca esagonale	6-8-10-11-12-13-14 mm	7
Chiavi a bussola 1/4" con bocca TORX®	E6-E8-E10	3
Chiavi a bussola 1/4" con inserto a croce PH	1-2	2
Chiavi a bussola 1/4" con inserto a croce PZ	1-2	2
Chiavi a bussola 1/4" con inserto ad intaglio	0,6x4-1,2x7	2
Chiavi a bussola 1/4" con inserto esagonale maschio	3-4-5-6	4
Chiavi a bussola 1/4" con inserto TORX®	T8-T10-T15-T20-T25-T27-T30	7
Prolunghe 1/4"	50-100 mm	2
Snodo cardanico 1/4"		1
Leva a T 1/4"		1
Impugnatura porta-bussole 1/4"		1
Cricchetto reversibile 1/4"		1

DESCRIZIONE	MISURA	PZ.
Chiavi a bussola 1/2" con bocca esagonale	10-11-12-13-14-15-16-17-18-19-20-21-22-24-27-30-32 mm	17
Chiavi a bussola 1/2" lunghe con bocca esagonale	13-14-15-17-19-22 mm	6
Chiavi a bussola 1/2" con bocca TORX®	E12-E14-E16-E18-E20-E24	6
Chiavi a bussola 1/2" per candele	16-21 mm	2
Prolunghe 1/2"	130-250 mm	2
Snodo cardanico 1/2"		1
Cricchetto reversibile 1/2"		1
Riduttore	1/2"-3/8"	1
Chiave a bussola portainseri	1/2"-5/16"	1
Inserti 5/16" ad intaglio	8-12	2
Inserti 5/16" a croce PH	3-4	2
Inserti 5/16" a croce PZ	3-4	2
Inserti 5/16" TORX®	T40-T45-T50-T55	4
Inserti 5/16" esagonali maschio	8-10-12-14 mm	4
Inserti 5/16" XZN	6-8-10-12	4

LA QUALITÀ **USAG** A UN PREZZO *Just*



8÷22 mm



82 PEZZI

601 1/4-1/2 J82

Cod. U06010010

Assortimento in cassetta modulare con bussole esagonali e chiavi combinate

1/2"

1/4"

7 kg 415 mm 92 mm 283 mm

€ 264,00

€ 169,00



MODULARE CON I CASSETTI DEI CARRELLI USAG!



DESCRIZIONE	MISURA	PZ.
Chiavi combinate	8-10-11-12-13-14-17-19-22 mm	9
Chiavi a bussola 1/4" con bocca esagonale	4-4,5-5-5,5-6-7-8-9-10-11-12-13-14 mm	13
Prolunghe 1/4"	55-100 mm	2
Prolunga flessibile	150 mm	1
Cricchetto reversibile 1/4"		1
Impugnatura porta-bussole 1/4"		1
Snodo cardanico 1/4"		1
Leva a T 1/4"		1
Bussola portainseri	1/4"-1/4"	1
Chiavi a bussola 1/4" con inserto ad intaglio	4-5,5-7	3
Chiavi a bussola 1/4" con inserto a croce PH	1-2	2
Chiavi a bussola 1/4" con inserto a croce PZ	1-2	2

DESCRIZIONE	MISURA	PZ.
Chiavi a bussola 1/4" con inserto esagonale maschio	3-4-5-6	4
Chiavi a bussola 1/4" con inserto TORX®	T8-T10-T15-T20-T25-T30	6
Chiavi a bussola 1/2" con bocca esagonale	14-15-16-17-18-19-20-22-24-27-30-32 mm	12
Chiavi a bussola 1/2" per candele	16-21 mm	2
Prolunghe 1/2"	130-250 mm	2
Cricchetto reversibile 1/2"		1
Snodo cardanico 1/2"		1
Adattatore per leva a T 1/2"	1/2"-5/16"	1
Riduttore	1/2"-3/8"	1
Inseri 1/4" ad intaglio	8-10-12	3
Inseri 1/4" a croce PH	3-4	2
Inseri 1/4" a croce PZ	3-4	2
Inseri 1/4" esagonali maschio	8-10-12-14 mm	4
Inseri 1/4" TORX®	T40-T45-T50-T55	4



1 kg 190 mm 58 mm 144 mm

16
PEZZI

601 1/4-1/2 JTX16

Cod. U06010009



1/2"

1/4"

Assortimento in cassetta modulare con bussole TORX®

DESCRIZIONE	MISURA	PZ.
Chiavi a bussola 1/4 TORX®	E6-E7-E8-E10	4
Chiavi a bussola 1/2 TORX®	E12-E14-E16-E18	4
Chiavi a bussola 1/4 con inserto TORX®	T10-T15-T20-T25	4
Chiavi a bussola 1/2 con inserto TORX®	T30-T40-T45-T50	4

~~€ 37,30~~

€ 26,00



1 kg 190 mm 58 mm 144 mm

34
PEZZI

601 1/4 J34

Cod. U06010001



1/4"

Assortimento in cassetta modulare con bussole esagonali ed inserti per avvitatura

DESCRIZIONE	MISURA	PZ.
Chiavi a bussola 1/4"	4-4,5-5-5,5-6-7-8-9-10-11-12-13-14	13
Cricchetto reversibile 1/4"		1
Snodo cardanico 1/4"		1
Prolunghe 1/4"	55-100	2
Inserti a intaglio	4-5,5-6	3
Inserti a croce POZIDRIV®	1-2-3	3
Inserti esagono maschio	4-5-6	3
Inserti TORX®	T10-T15-T20-T25-T30-T40	6
Impugnatura maschio/femmina		1
Raccordo portainseri 1/4"		1

~~€ 71,50~~

€ 46,50



4 kg 375 mm 80 mm 186 mm

22
PEZZI

601 1/2 J22

Cod. U06010003



1/2"

Assortimento in cassetta modulare con bussole esagonali

DESCRIZIONE	MISURA	PZ.
Bussole esagonali 1/2"	8-10-11-12-13-14-15-16-17-18-19-21-22-24-27-30-32	17
Cricchetto 1/2"		1
Prolunghe 1/2"	130-250	2
Snodo cardanico 1/2"		1
Leva a T 1/2"		1

~~€ 105,00~~

€ 68,00

LA QUALITÀ **USAG** A UN PREZZO *Just*



32
PEZZI

692 J32

Cod. U06920042

Assortimento di inserti con cricchetto

1/4

DESCRIZIONE	MISURA		PZ.
Inserti ad intaglio	4-5,5-6,5-8	⊖	4
Inserti a croce PHILLIPS®	PH 1-2-3	⊕	3
Inserti a croce POZIDRIV®	PZ 1-2-3	⊕	3
Inserti esagono maschio	3-4-5-6	⊙	4
Inserti TORX®	T8-10-15-20-20-25-25-30-40	⊗	9
Inserti TORX® Tamper Resistant	STX 10-15-20-25-27-30-40	⊗	7
Portainseri magnetico			1
Cricchetto			1

280 g | mm | 138
30
98

~~€ 46,60~~

€ 32,00



49
PEZZI

692 J49

Cod. U06920041

Assortimento di inserti

1/4

DESCRIZIONE	MISURA		PZ.
Inserti ad intaglio	4-4,5-5,5-6,5-6,5-8	⊖	6
Inserti a croce PHILLIPS®	PH 1-1-2-2-2-3	⊕	6
Inserti a croce POZIDRIV®	PZ 1-1-2-2-2-3-3	⊕	7
Inserti esagono maschio	2-3-3-4-4-5-5-6-6	⊙	9
Inserti TORX®	TX 10-10-15-15-20-20-25-25-30-30	⊗	10
Inserti TORX® Tamper Resistant	STX 10-15-15-20-20-25-25-30-30-40	⊗	10
Portainseri magnetico			1

280 g | mm | 138
30
98

~~€ 36,00~~

€ 26,50



100
PEZZI

692 J100

Cod. U06920043

Assortimento di inserti con impronte speciali

1/4

DESCRIZIONE	MISURA		PZ.
Inserti a intaglio	3-4-4,5-5-5,5-6-6,5-7-8	⊖	9
Inserti a croce	PH 00-0-1-1-2-2-3-4 - PZ 1-2-2-3-4	⊕⊕	13
Inserti esagono maschio	1,5-2-2,5-3-4-5-5,5-6-7-8 mm 1/16-5/64-3/32-7/64-1/8-9/64-5/32-3/16-7/32-1/4"	⊙	20
Inserti TORX®	T 8-9-10-15-20-25-27-30-40-45	⊗	10
Inserti TORX® Tamper Resistant	STX 8-10-15-20-25-27-30-35-40	⊗	9
Inserti Tri-Wing	1-2-3-4	⊕	4
Inserti Spanner	4-6-8-10-12	⊕	5
Inserti Torq-set	6-8-10	⊕	3
Inserti quadrati	0-1-2-2-3	⊕	5
Inserti Clutch	1/8-5/32-3/16-1/4-5/16	⊕	5
Inserti XZN	M5-M6-M8	⊕	3
Inserti esagono maschio con foro	2-2,5-3-4-5-6 mm - 5/64-3/32-7/64-1/8-9/64-5/32"	⊕	12
Portainseri magnetici	1/4x60mm		2

900 g | mm | 215
45
150

~~€ 55,50~~

€ 41,00



Prolunghe a catena

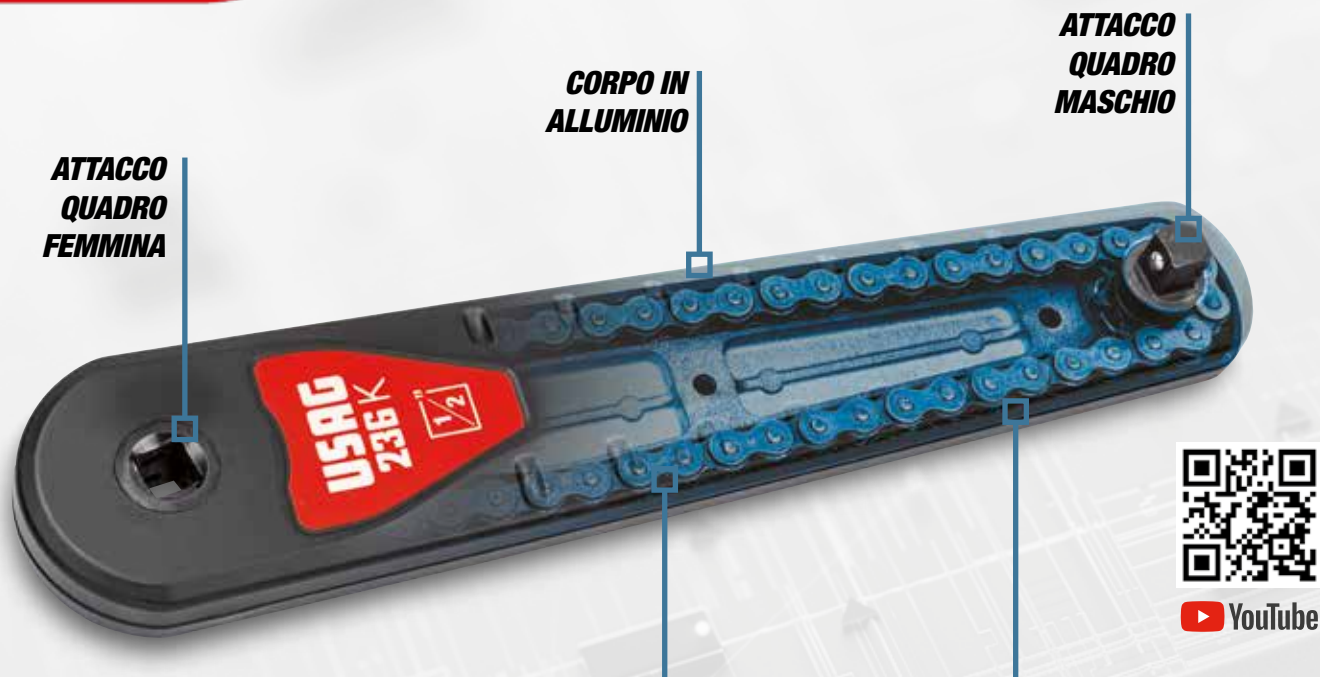

RAPPORTO DI TRASMISSIONE SISTEMA CORONA-PIGNONE.

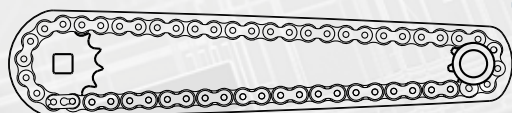

CORONA

per attacco utensile.

PIGNONE

PIÙ GIRI IN USCITA.

MASSIMA ACCESSIBILITÀ DIMENSIONI TESTA COME UN CRICCHETTO*.

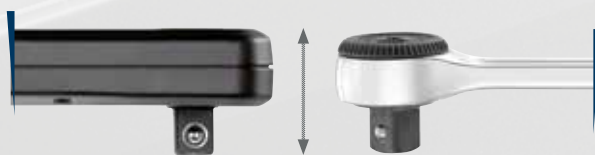

39 mm

*Confronto con cricchetto da 1/2".

UTILIZZO CON CRICCHETTO



VANTAGGI:

- 1** **MAGGIOR SPAZIO DI MANOVRA.**
- 2** **MOLTIPLICA I GIRI IN USCITA FINO A 1,6 VOLTE.**

UTILIZZO CON AVVITATORE



VANTAGGI:

- 1** **PER INTERVENTI IN SPAZI RISTRETTI.**
- 2** **AUMENTO FREQUENZA IMPULSI AL MINUTO FINO AL 20%.**



1/2"

236 K

Prolunga a catena in alluminio

1/4"

CODICE	□	L	H	📏
U02360700	1/2"	340 mm	39 mm	1,1 kg
U02360698	1/4"	260 mm	27 mm	300 g

~~€ 100,00~~ € 69,00

~~€ 75,00~~ € 49,00



13 PEZZI

236 K/C13

Cod. U02360852



1/2"

Assortimento in cassetta modulare con bussole esagonali macchina

📏 435
📏 70
📏 270
📏 mm

DESCRIZIONE	ART./MISURA	PZ.
Prolunga a catena	236 K 1/2"	1
Bussole esagonali macchina	235 1/2 M 10-11-12-13-14-15-16-17-18-19-22-24	12

~~€ 240,15~~

€ 168,00



20 PEZZI

236 K/C20

Cod. U02360851



1/2"

Assortimento in cassetta modulare con bussole esagonali, cricchetto ed accessori

📏 435
📏 70
📏 270
📏 mm

DESCRIZIONE	ART./MISURA	PZ.
Prolunga a catena	236 K 1/2"	1
Bussole esagonali	235 1/2" EN 10-11-12-13-14-15-16-17-18-19-21-22-24-27-30-32	16
Snodo cardanico	241 1/2"	1
Cricchetto reversibile certificato IP51	237 A 1/2"	1
Prolunga	236 1/2" 125	1

~~€ 292,02~~

€ 204,00



27 PEZZI

236 K/C27

Cod. U02360850



1/4"

Assortimento in cassetta modulare con bussole esagonali, cricchetto, accessori e inserti

📏 330
📏 60
📏 215
📏 mm

DESCRIZIONE	ART./MISURA	PZ.
Prolunga a catena	236 K 1/4"	1
Bussole esagonali	235 1/4" EN 5,5-6-7-8-9-10-11-12-13-14	10
Cricchetto reversibile certificato IP51	237 A 1/4"	1
Bussola portainseriti	684 1/4"	1
Prolunghe	236 1/4" 50-100	2
Inserti a croce PHILLIPS®	660 PH 1-2-3	3
Inserti esagono maschio	660 E 3-4-5-6-7	5
Inserti TORX® Tamper Resistant	660 STX T15-T20-T25-T30	4

~~€ 209,41~~

€ 146,00



16
PEZZI

687 1/2 C16
Cod. U06870100

1 1/2"

Assortimento in cassetta di ABS con inserti macchina

- Cassetta in ABS ad alta resistenza con sistema di chiusura rapida.

DESCRIZIONE	ART./MISURA	PZ.
Portainseri	685 6 1/2	1
Portainseri	685 8 5/16	1
Inserti esagono maschio 1/2	687 E 6-7-8-10-12-14	6
Inserti TORX 1/2	687 TX T30-T40-T45-T50-T55	5
Inserti PHILLIPS 5/16	686 PH 2-3-4	3

~~€ 162,00~~ **€ 113,00**



6
PEZZI

688 3/4 MD6
Cod. U06880010

3 3/4"

Assortimento in cassetta di ABS con inserti macchina

- Cassetta in ABS ad alta resistenza con sistema di chiusura rapida.

DESCRIZIONE	ART./MISURA	PZ.
Portainseri	685 B 1 7/8	1
Inserti esagono maschio 7/8	688 E 12-17-19-22-24	5

~~€ 198,00~~ **€ 139,00**



Gamma porta inserti 685 B e inserti macchina 688

ANTICORROSIONE E ANTIUSURA

Acciaio al cromo molibdeno e fosfatazione al manganese.

ISO 9227

SPINA DI TENUTA

Garantisce maggior tenuta dell'inserto nella sede rispetto al grano di bloccaggio.

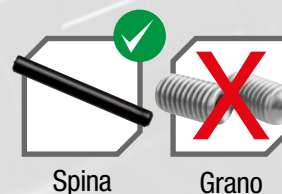

NEW



7
PEZZI

235 1/2 MN/C7

Cod. U02359282



1 1/2"

Assortimento in cassetta di ABS con bussole macchina

- Cassetta in ABS ad alta resistenza con sistema di chiusura rapida.

DESCRIZIONE	ART./MISURA	PZ.
Chiavi a bussola macchina con bocca esagonale	235 1/2 M 10-13-14-17-19-22-24	7

~~€ 79,00~~

€ 55,00

NEW



7
PEZZI

235 3/4 M/D7

Cod. U02359284



3 3/4"

Assortimento in cassetta di metallo con bussole macchina

- Cassetta in ABS ad alta resistenza con sistema di chiusura rapida.

DESCRIZIONE	ART./MISURA	PZ.
Chiavi a bussola macchina con bocca esagonale	235 3/4 M 17-19-22-24-27-30-32	7

~~€ 167,00~~

€ 117,00



**ISO 2725-2
ISO 1174-2**

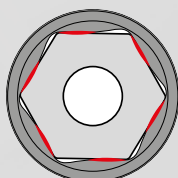

Gamma bussole esagonali macchina

PROFILO MIGLIORATO

Maggiore contatto tra bussola e superficie piana di dado o vite.

ESECUZIONE FOSFATATA

ISO 9227

MARCATURA LASER

Logo e misura più visibile (misure 1" e 1 1/2" per incisione).

ACCIAIO SPECIALE

Cromo molibdeno per superiore resistenza agli impatti.





IL TOP DI GAMMA

**ILLUMINAZIONE
A LED**

**REMOVIBILE E
RICARICABILE.**



1/2"

943 PC1 1/2"

Cod. U09430001

Avvitatore ad impulsi in magnesio

- Carter in lega di magnesio.
- Alloggiamento corpo motore in alluminio.
- Unità LED rimovibile e ricaricabile tramite USB (Batteria Li-Ion 3.7V 180 mAh).
- Modello reversibile con meccanismo a doppio martello.
- 3 livelli di potenza impostabili per il serraggio, coppia sempre al massimo in svitatura.
- Pulsante di controllo dell'aria progressivo.
- Paracolpi laterali in gomma.
- Peso bilanciato per il massimo comfort.
- Impugnatura bimatereale soft-touch.
- Silenziatore e scarico dell'aria integrati nell'impugnatura.

**CARTER IN LEGA
DI MAGNESIO**

ULTRALEGGERO E RESISTENTE.

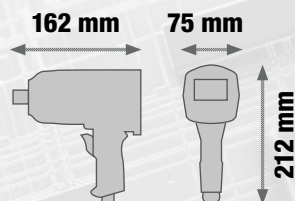

**1.898
Nm**

**2,2
kg**

CARATTERISTICHE TECNICHE

Attacco quadro	1/2"
Capacità bullone	M20
Coppia massima	1.898 Nm
Coppia di lavoro	320÷460 Nm
Impulsi al minuto	1200
Velocità a vuoto	6.500 giri/min
Consumo medio aria	172 l/min

CARATTERISTICHE TECNICHE

Pressione aria raccomandata	6,2 bar
Pressione sonora	94 ±3 dB(A)
Potenza sonora	105 ±3 dB(A)
Vibrazioni	6,4 m/s ²
Attacco aria	1/4"
Diametro interno tubo aria	10 mm
Peso	2,2 kg

~~€ 435,00~~

€ 299,00

IL COMPATTO

**ILLUMINAZIONE
A LED**

**REMOVIBILE E
RICARICABILE.**



1/2"

943 PC2 1/2"

Cod. U09430002

**Avvitatore ad impulsi in magnesio con LED
Extra compatto**

- Carter in lega di magnesio: ultraleggero e resistente.
- Alloggiamento corpo motore in alluminio.
- Modello reversibile con meccanismo a doppio martello.
- 3 livelli di potenza impostabili per il serraggio, coppia sempre al massimo in svitatura.
- Inversione e regolazione con leva in alluminio.
- Pulsante di controllo dell'aria progressivo.
- Paracolpi laterali in gomma.
- Peso bilanciato per il massimo comfort.
- Impugnatura bimatereale soft-touch.
- Silenziatore e scarico dell'aria integrati nell'impugnatura.

**CARTER IN LEGA
DI MAGNESIO**

ULTRALEGGERO E RESISTENTE.

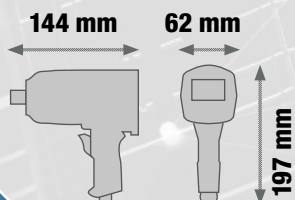

**950
Nm**

**1,4
kg**

CARATTERISTICHE TECNICHE

Attacco quadro	1/2"
Capacità bullone	M16
Coppia massima	950 Nm
Coppia di lavoro	200÷270 Nm
Impulsi al minuto	1400
Velocità a vuoto	10.000 giri/min
Consumo medio aria	167 l/min

CARATTERISTICHE TECNICHE

Pressione aria raccomandata	6,2 bar
Pressione sonora	95±3 dB(A)
Potenza sonora	107±3 dB(A)
Vibrazioni	3,9 m/s ²
Attacco aria	1/4"
Diametro interno tubo aria	10 mm
Peso	1,4 kg

~~€ 370,00~~

€ 259,00



IL MODELLO DI RIFERIMENTO



**CARTER
IN LEGA DI
MAGNESIO
ULTRALEGGERO
E RESISTENTE.**

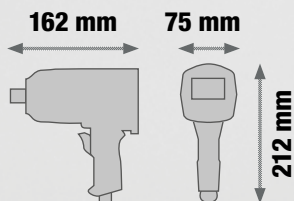

1/2"

929 PC1 1/2"

Cod. U09290001

Avvitatore ad impulsi in magnesio

- Carter in lega di magnesio.
- Alloggiamento corpo motore in alluminio.
- Modello reversibile con meccanismo a doppio martello.
- 3 livelli di potenza impostabili per il serraggio, coppia sempre al massimo in svitatura.
- Pulsante di controllo dell'aria progressivo.
- Paracolpi laterali in gomma.
- Peso bilanciato per il massimo comfort.
- Impugnatura bimateriale soft-touch.
- Silenziatore e scarico dell'aria integrati nell'impugnatura.

CARATTERISTICHE TECNICHE

Attacco quadro	1/2"
Capacità bullone	M16
Coppia massima	1.600 Nm
Coppia di lavoro	280÷440 Nm
Impulsi al minuto	1.300
Velocità a vuoto	7.000 giri/min
Consumo medio aria	172 l/min

CARATTERISTICHE TECNICHE

Pressione aria raccomandata	6,2 bar
Pressione sonora	93 ±3 dB(A)
Potenza sonora	104 ±3 dB(A)
Vibrazioni	6,2 m/s ²
Attacco aria	1/4"
Diametro interno tubo aria	10 mm
Peso	2,0 kg

~~€ 335,00~~

€ 230,00

L'AVVITATORE IN ALLUMINIO



CORPO IN ALLUMINIO

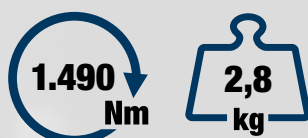
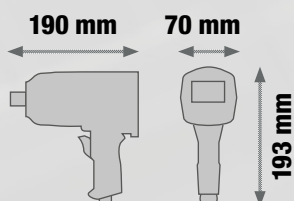

1/2"

928 AC1 1/2"

Cod. U09280014

Avvitatore ad impulsi in alluminio

- Alloggiamento corpo motore in alluminio.
- Carter in acciaio.
- Modello reversibile con meccanismo a doppio martello.
- Regolatore di potenza in 7 livelli, in entrambi i sensi di rotazione.
- Pulsante di controllo dell'aria progressivo.
- Impugnatura bimateriale soft-touch.
- Silenziatore e scarico dell'aria integrati nell'impugnatura.

CARATTERISTICHE TECNICHE

Attacco quadro	1/2"
Capacità bullone	M16
Coppia massima	1.490 Nm
Coppia di lavoro	135÷380 Nm
Impulsi al minuto	1.120
Velocità a vuoto	6.500 giri/min
Consumo medio aria	147 l/min

CARATTERISTICHE TECNICHE

Pressione aria raccomandata	6,2 bar
Pressione sonora	90 ±3 dB(A)
Potenza sonora	101 ±3 dB(A)
Vibrazioni	5,2 m/s ²
Attacco aria	1/4"
Diametro interno tubo aria	10 mm
Peso	2,8 kg

~~€ 264,00~~

€ 181,00



1/2"

942 PC3 1/2"

Cod. U09420012

Avvitatore ad impulsi - extra compatto

- Struttura extra compatta: 11 cm di lunghezza.
- Modello reversibile con sistema di percussione JUMBO.
- Motore monoblocco.
- Scarico dell'aria convogliato nell'impugnatura.
- 3 livelli di potenza impostabili per il serraggio, coppia sempre al massimo in svitatura.
- Corpo ed impugnatura in materiale antiscivolo.
- Paracolpi laterali a protezione del carter motore.
- Peso bilanciato per il massimo comfort anche per uso prolungato.

CARATTERISTICHE TECNICHE		CARATTERISTICHE TECNICHE	
Attacco quadro	1/2"	Pressione aria raccomandata	6,2 bar
Capacità bullone	M16	Pressione sonora	91,1±3 dB(A)
Coppia massima	861 Nm	Potenza sonora	108,1±3 dB(A)
Coppia di lavoro	150÷220 Nm	Vibrazioni	9,57 m/s ²
Impulsi al minuto	1650	Attacco aria	1/4"
Velocità a vuoto	10.000 giri/min	Diametro interno tubo aria	10 mm
Consumo medio aria	127 l/min	Peso	1,3 kg

~~€ 216,00~~

€ 159,00

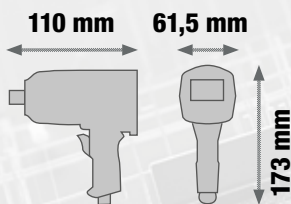

222 mm



3/4"

928 D1 3/4"

Cod. U09280015

Avvitatore ad impulsi in alluminio

- Modello reversibile con meccanismo a doppio martello.
- 6 livelli di potenza impostabili in avvitamento e svitamento.

CARATTERISTICHE TECNICHE		CARATTERISTICHE TECNICHE	
Attacco quadro	3/4"	Pressione aria raccomandata	6,2 bar
Capacità bullone	M24	Pressione sonora	98,4±3 dB(A)
Coppia massima	1.700 Nm	Potenza sonora	109,4±3 dB(A)
Coppia di lavoro	500÷1.050 Nm	Vibrazioni	9,1 m/s ²
Impulsi al minuto	790	Attacco aria	3/8"
Velocità a vuoto	5.700 giri/min	Diametro interno tubo aria	13 mm
Consumo medio aria	193 l/min	Peso	5,6 kg

~~€ 815,00~~

€ 570,00

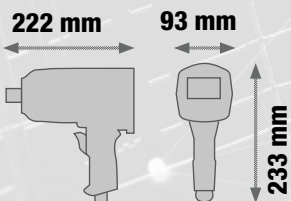



TESTA PIATTA E COMPATTA

ideale per l'uso in spazi ristretti.



1/2"

136 Nm

1,2 kg

913 PC2 1/2"

Cod. U09130017

Cricchetto in materiale composito

- Modello reversibile ultracompatto.
- Scarico dell'aria posteriore.
- Corpo esterno in materiale composito ad alta resistenza.
- Carter anteriore in acciaio.

CARATTERISTICHE TECNICHE

Attacco quadro	1/2"
Capacità bullone	M10
Coppia massima	136 Nm
Velocità a vuoto	280 giri/min
Consumo medio aria	113 l/min
Pressione aria raccomandata	6,2 bar

CARATTERISTICHE TECNICHE

Pressione sonora	99±3 dB(A)
Potenza sonora	110±3 dB(A)
Vibrazioni	9,1 m/s ²
Attacco aria	1/4"
Diametro interno tubo aria	10 mm
Peso	1,2 kg

~~€ 284,00~~

€ 199,00



30.000 Giri/min

0,3 CV
220 W

Ø 6 mm

922 B1

Cod. U09220001

Smerigliatrice dritta

CARATTERISTICHE TECNICHE

Consumo medio aria	76 l/min
Pressione aria raccomandata	6,2 bar
Pressione sonora	84,8±3 dB(A)
Potenza sonora	99,5±3 dB(A)

CARATTERISTICHE TECNICHE

Vibrazioni	2,42 m/s ²
Attacco aria	1/4"
Diametro interno tubo aria	10 mm
Peso	440 g

~~€ 136,00~~

€ 95,00



CAVO 16 m
Ø 10 mm

939 C1

Cod. U09390004

Avvolgitubo aria

- Modello a recupero automatico del tubo con dispositivo d'arresto.
- Corpo in materiale plastico antiurto con staffa girevole per il fissaggio a parete.
- Conformità alla direttiva macchine 2006/42/CE e alle norme ISO EN 12100-1 e ISO EN 12100-2.
- Tubo in poliuretano lucido.

CARATTERISTICHE TECNICHE

Lunghezza tubo	16 m
Diametro interno tubo	10 mm
Pressione max di utilizzo	15 bar

CARATTERISTICHE TECNICHE

Raccordo in uscita	3/8"
Dimensioni (inclusa staffa)	450x400x230 mm
Peso	8 kg

~~€ 280,00~~

€ 196,00



Base magnetica regolabile a 180°

250 mm

DOPPIA FUNZIONE



LAMPADA



TORCIA

RICARICABILE



889 RD

Cod. U08890035

Lampada di ispezione a LED

~~€ 96,50~~

€ 67,00



YouTube



SMD LED



Lampada: 5 h
Torcia: 9 h



IK07



IP20



4,5 h



Li-ion



Gancio flessibile

Magnete

300 mm

SOLO 12 mm

Magnete

2 LIVELLI DI LUMINOSITÀ



INDICATORE DI CARICA

889 SA

Cod. U08890019

Lampada ispezione a LED extra sottile ad alta luminosità

~~€ 114,00~~

€ 79,00



YouTube



COB LED



2,5/5 h



IK06



IP54



4 h



Li-Poly

360°



YouTube

DOPPIA FUNZIONE

RICARICABILE



LAMPADA (180 LUMEN).
TORCIA (60 LUMEN).

889 RP

Cod. U08890045

Lampada a LED ricaricabile compatta

~~€ 58,00~~

€ 40,00

180°

131 mm

- Lampada COB LED
- Torcia SMD LED
- Lampada: 3h
Torcia: 10h
- IP20
- 4,5 h
- Li-ion

NEW



156 mm

- SMD LED
- 2/5 h
- Li-ion
- IP54
- 6 h

200/600 LUMEN



889 TR

Cod. U08890073

Torcia LED in alluminio ricaricabile

~~€ 65,00~~

€ 45,50

170 mm

180°

130 mm

- COB LED
- IP67
- 2,5 h
- 1 = 8 h
2 = 4 h
3 = 2,5 h
- IK07
- Li-ion

3 LIVELLI DI LUMINOSITÀ

MAX 1500 LUMEN



500, 1000 e 1500 lumen con un semplice tocco.

889 RT

Cod. U08890038

Faretto a LED ricaricabile - certificato IP67

~~€ 250,00~~

€ 175,00

Base magnetica



YouTube



FUNZIONA CON O SENZA CAVO!

Cavo da 5 metri incluso.

Forbici per elettricisti



L'UNICA CON STRUTTURA INTEGRALE IN ACCIAIO INOX
resiste alla flessione fino a 180 kg.



YouTube



207 E

Cod. U02070006

Forbice professionale per elettricisti

~~€ 34,60~~

€ 25,00



SPELLAFILI INTEGRATO



1. Spellatura.
2. Crimpatura.

TAGLIACAVI SU ENTRAMBE LE LAME



Adatto per cavi multipolari.

LAMA MICRODENTATA ANTISCIVOLO



NUOVA FORBICE PER ELETTRICISTI



IMPUGNATURA RESISTENTE ALLA FLESSIONE FINO A 80 kg
in tecnopolimero caricato vetro.

50 mm²

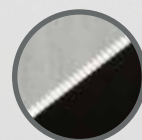

LAME FLUIDE E ROBUSTE

In acciaio inox con microdentatura e tagliacavi.



ASOLE MAGGIORATE



207 D

Cod. U02070008

Forbice professionale per elettricisti

~~€ 22,70~~

€ 15,90



YouTube

360°



TESTA ORIENTABILE



NEW

ALLUMINIO

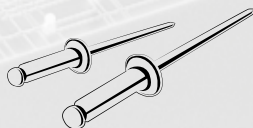

- Ø 2,4 mm
3/32"
- Ø 3,2 mm
1/8"
- Ø 4,0 mm
5/32"
- Ø 4,8 mm
3/16"

995 AF

Cod. U09950006

Rivettatrice con testa orientabile

- Testa orientabile liberamente a 360°.
- Adatta a rivetti in alluminio.
- 4 testine intercambiabili.
- Corpo in lega leggera.
- Manici in materiale plastico.
- Clip in metallo per blocco apertura.
- Chiave smontaggio testine in dotazione.

~~€ 30,00~~

€ 21,00



Serbatoio porta steli

NEW

COMPATTA E POTENTE

Solo 330 mm di lunghezza
20% di sforzo in meno rispetto al modello standard.

330 mm

**-20%
DI SFORZO**

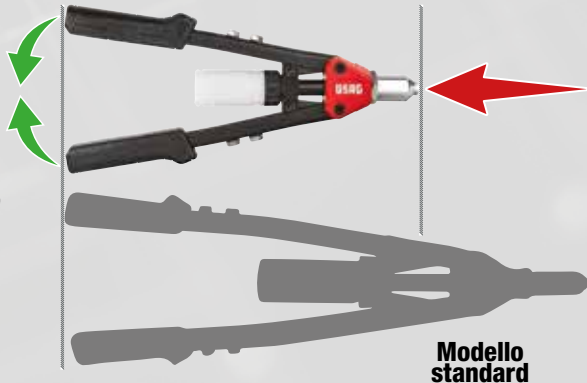

Modello standard

995 LA

Cod. U09950004

Rivettatrice dritta compatta

- Modello compatto con la stessa capacità di una rivettatrice lunga standard.
- Il sistema di leve interno riduce lo sforzo dell'operatore.
- Adatta a rivetti in alluminio ed acciaio
- 5 testine intercambiabili.
- Serbatoio amovibile per recupero steli.
- Corpo in lega leggera.
- Manici in materiale plastico.

~~€ 52,90~~

€ 37,00

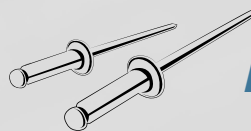

ALLUMINIO E ACCIAIO

- Ø 2,4 mm
3/32"
- Ø 3,2 mm
1/8"
- Ø 4,0 mm
5/32"
- Ø 4,8 mm
3/16"
- Ø 6,4 mm
1/4"

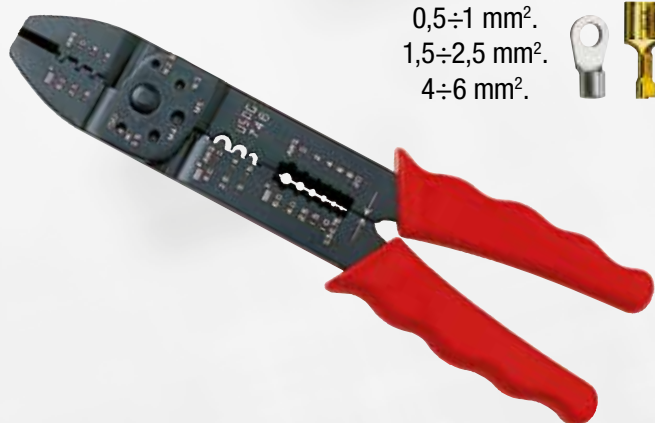

0,5÷1 mm².
1,5÷2,5 mm².
4÷6 mm².



746

Cod. U07460001

Pinza per capicorda non isolati aperti e chiusi

- Modello con troncaviti, troncafilì e spellafilì.
- Impugnature in PVC.
- Corpo in lamiera d'acciaio tranciata.

~~€ 33,50~~

€ 23,50



765

Cod. U07650001

Pinza per fascette

- Modello per fascette in nylon fino a 9 mm di larghezza.
- Lama per il taglio della parte eccedente.
- Corpo in lamiera d'acciaio imbutita.

~~€ 32,60~~

€ 23,00



8
PEZZI

342 SE8

Cod. U03420088

Serie di 8 giraviti di precisione per viti con intaglio e impronta a croce PHILLIPS®

- Fornita in busta di plastica.

~~€ 74,55~~

€ 52,00

⊖ 0,8-1-1,4-1,6-2 mm ⊕ PH00-PH0-PH1

POTENZA
15÷25
Watt

MAX
495
C°

063 W

Cod. U00630002

Saldatore a stilo elettronico a doppia potenza

- Saldatore professionale per stagno.
- Commutatore di potenza a pulsante.
- Ideale per diversi tipi di applicazioni in campo elettrotecnico.
- Punta in acciaio ad alta durata.
- Corpo in materiale plastico resistente ad olii ed idrocarburi.
- Alimentazione 230V.
- Fornito con supporto da banco.

~~€ 57,00~~

€ 40,00



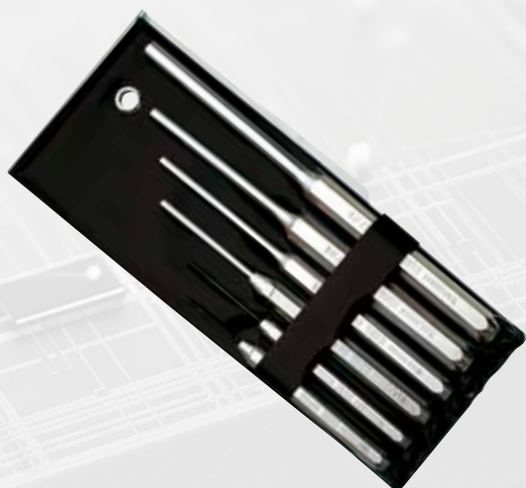

6
PEZZI

367 SE6

Cod. U03670081

Serie di 6 cacciaspina

- 367/2x110-3x130-4x145-5x165-6x180-8x200 mm.
- Fornita in busta di plastica.
- Acciaio al Cromo Vanadio.
- Punte riportate e fosfatate per le misure da 2 e 3 mm.

~~€ 48,18~~

€ 33,50

Forza scatto
110÷220 N



368 B

Cod. U03680001

Bulino automatico

- Modello con sistema di scatto a molla.
- Profondità di incisione regolabile mediante rotazione della testa.
- Punta riaffilabile.
- Forza scatto: 110÷220 N.

~~€ 25,60~~

€ 18,00



UNI 7777
DIN 6475

Testa in acciaio al carbonio forgiata e sottoposta a trattamento termico differenziato per garantire una maggiore durata ed evitare scheggiature o ricalcature della superficie battente.

382

Martelli per meccanici

- Modello tedesco a testa quadra piana e penna simmetrica.
- Manico in frassino.

CODICE	PESO TESTA	LUNGHEZZA	€	€
U03820002	100 g	260 mm	€ 10,00	€ 7,00
U03820004	200 g	280 mm	€ 10,30	€ 7,20
U03820006	300 g	300 mm	€ 11,40	€ 8,00
U03820007	400 g	310 mm	€ 13,60	€ 9,50
U03820008	500 g	320 mm	€ 15,40	€ 11,00
U03820009	600 g	330 mm	€ 17,60	€ 12,30
U03820010	800 g	350 mm	€ 20,50	€ 14,40
U03820011	1000 g	360 mm	€ 23,10	€ 16,00
U03820013	1500 g	380 mm	€ 30,80	€ 22,00
U03820014	2000 g	400 mm	€ 40,00	€ 28,00



RAME

Ø
3-16
mm

Ø
1/8-5/8
"

314 A

Cod. U03140010

Tagliatubi per tubi in rame e lega leggera

- Modello compatto a limitato raggio di rotazione per operare in spazi ristretti.
- Rulli di scorrimento scanalati per il taglio di tubi bordati.
- Spessore massimo: 2 mm.
- Corpo in lega leggera.
- Esecuzione verniciata.

~~€ 25,50~~

€ 18,00



RAME

Ø
3-35
mm

Ø
1/8-1 3/8
"

314 DA

Cod. U03140033

Tagliatubi per tubi in rame e lega leggera

- Modello ad avanzamento telescopico e ingombro costante.
- 4 rulli di scorrimento scanalati per il taglio di tubi bordati.
- Sostituzione rapida della rotella senza bisogno di utensili.
- Pomello ergonomico.
- Corpo in lega leggera.
- Esecuzione verniciata.
- Spessore massimo tubo: 2 mm.
- Lama svasatubi incorporata.
- Fornito con 2 rotelle, una montata e una nel pomello.

~~€ 61,00~~

€ 42,00



Ritorno della lama
con una sola mano



PLASTICA

Ø
42
mm

Ø
1 5/8
"

317 BM

Cod. U03170010

Tagliatubi per tubi e profilati in plastica

- Per tubi in PVC, multistrato e PEX.
- Azione di taglio progressiva con il minimo sforzo.
- Sostituzione rapida della lama senza bisogno di utensili.
- Lama completamente integrata nel corpo del prodotto.
- Lama in acciaio Inox con geometria speciale e rivestimento in PTFE.
- Ritorno della lama con una sola mano.
- Impugnatura ergonomica bimatériale.
- Dimensioni: 242x107x25 mm.

~~€ 76,00~~

€ 53,00

302 N

Giratubi modello americano

- Dispositivo a doppia molla per il bloccaggio immediato del tubo ed una rapida ripresa della manovra.
- Corpo in ghisa malleabile.
- Ganasce in acciaio al carbonio.

CODICE	CAPACITÀ	CAPACITÀ	LUNGHEZZA		
U03020003	1"	33 mm	200 mm	€ 22,90	€ 16,00
U03020004	1 1/2"	48 mm	250 mm	€ 29,10	€ 21,00
U03020005	2"	60 mm	350 mm	€ 39,20	€ 28,00
U03020006	2 1/2"	73 mm	450 mm	€ 57,50	€ 40,00
U03020007	3"	89 mm	600 mm	€ 89,50	€ 63,00

305 N

Giratubi modello svedese con ganasce a 90° diritte

- Acciaio al cromo vanadio.

CODICE	CAPACITÀ	CAPACITÀ	LUNGHEZZA		
U03050002	1"	40 mm	330 mm	€ 33,60	€ 24,00
U03050003	1 1/2"	55 mm	420 mm	€ 44,80	€ 32,00
U03050004	2"	67 mm	540 mm	€ 69,00	€ 49,00
U03050005	3"	103 mm	690 mm	€ 103,00	€ 72,00

308

Giratubi modello leggero con ganasce a 90°

- Acciaio al carbonio.

CODICE	CAPACITÀ	CAPACITÀ	LUNGHEZZA		
U03080001	1"	45 mm	175 mm	€ 27,10	€ 19,00
U03080002	1 1/2"	60 mm	225 mm	€ 30,60	€ 22,00
U03080003	1 3/4"	75 mm	275 mm	€ 37,60	€ 27,00
U03080004	2"	85 mm	315 mm	€ 42,10	€ 30,00
U03080005	3"	100 mm	360 mm	€ 74,00	€ 52,00

307 A/S7

Cod. U03070001

Chiave per sottolavelli

- Per il montaggio di rubinetti e miscelatori con fissaggio a dado.
- Braccio cavo di 25 cm di lunghezza.
- Estremità cava per dadi esagonali di 13 mm.
- Adattatori forniti: 9,10,11,12,14,17 mm.

€ 36,90	€ 25,90
--------------------	----------------

7
PEZZI



9÷17 mm

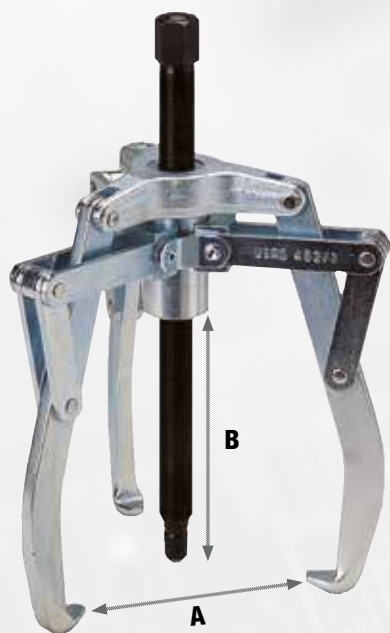

**COMPRESSE
NEL PREZZO**

452

Estrattori a tre bracci per esterni

- Modello a bracci autoserranti.
- Vite in acciaio al carbonio.
- Corpo in acciaio al cromo vanadio.
- Esecuzione zincocromatata e brunita.
- Per le misure n°5 e 6 è possibile la trasformazione dell'estrattore da meccanico ad idraulico sostituendo la vite di pressione in dotazione con la vite idraulica 452 IB.

CODICE	A	B	⬡		
U04520010	85 mm	70 mm	14 mm	€ 196,00	€ 137,00
U04520011	130 mm	110 mm	17 mm	€ 263,00	€ 184,00
U04520012	230 mm	170 mm	24 mm	€ 329,00	€ 230,00
U04520013	300 mm	240 mm	24 mm	€ 413,00	€ 289,00
U04520014	420 mm	240 mm	32 mm	€ 679,00	€ 475,00
U04520015	680 mm	295 mm	32 mm	€ 729,00	€ 510,00

454

Estrattori a due bracci per esterni

- Modello a bracci scorrevoli.
- Trave con esagono di supporto al serraggio.
- Bracci con unghiate ridotte.
- Vite in acciaio al carbonio.
- Corpo in acciaio al cromo vanadio.
- Esecuzione cromata e brunita.

CODICE	A	B	POTENZA	⬡		
U04540000	65 mm	70 mm	1,5 t	13 mm	€ 70,50	€ 50,00
U04540010	90 mm	110 mm	3 t	17 mm	€ 79,00	€ 55,00
U04540020	130 mm	110 mm	3 t	17 mm	€ 85,00	€ 60,00
U04540030	175 mm	165 mm	4 t	17 mm	€ 138,00	€ 97,00
U04540040	220 mm	165 mm	4 t	17 mm	€ 152,00	€ 106,00
U04540050	270 mm	220 mm	5 t	21 mm	€ 213,00	€ 149,00
U04540060	340 mm	220 mm	5 t	21 mm	€ 239,00	€ 167,00

**4
PEZZI**

451 N/S4

Cod. U04510100

Estrattore a tre bracci per esterni

- Modello a bracci autoserranti.
- Capacità: 7÷140 mm.
- Potenza: 3 ton.
- Spina di sicurezza.
- Vite di manovra con esagono da 18 mm.
- Possibilità di utilizzo a due bracci.
- Viti di manovra M16x2.

~~€ 210,00~~ **€ 147,00**

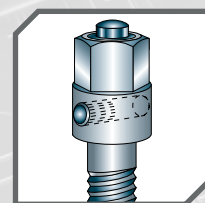

Spina di sicurezza: utilizzo sicuro e qualità dell'attrezzo preservata

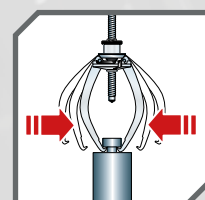

Autoserrante
Autocentrante

SCARPE ANTINFORTUNISTICHE S1P TOMAIA ALTAMENTE TRASPIRANTE

SOLETTA AMMORTIZZANTE

Confortevole, anatomica, antibatterica.

Made in Italy

S1P
SRC
ESD

TOMAIA IN MESH CON MICROFIBRA

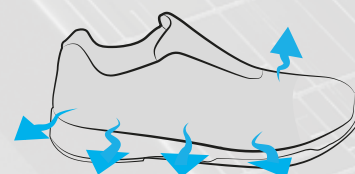

TRASPIRANTE

CALZATA



PUNTALE IN COMPOSITO

SUOLA IN POLIURETANO BIDENSITÀ

iniettata direttamente sulla tomaia per la massima qualità.

INTERSUOLA ANTIPERFORAZIONE

100%
METAL
FREE

3500 S1P

Scarpe antinfortunistiche con tomaia traspirante

- Categoria S1P.
- Calzatura bassa in Mesh con microfibra sovrastampata.
- Fodera 100% poliestere con lavorazione a nido d'ape per migliorare il ricircolo dell'aria a vantaggio della traspirazione.
- Puntale in composito leggero e resistente.
- Soletta estraibile preformata, in poliuretano bicolore e bi-densità, traspirante, lavabile ed antibatterica. Offre ottime performance in termini di comfort e di ammortizzamento.
- Suola in poliuretano bi-densità resistente alle flessioni ed alle abrasioni, antiolio, antiscivolo.
- Intersuola confortevole antiperforazione.
- Calzata 12.
- 100% metal free.
- Campi di impiego suggeriti: Lavori leggeri, industria meccanica, logistica/imballaggio.



EN ISO 20345: 2011

TAGLIA	CODICE	TAGLIA	CODICE
36	U35000036	42	U35000042
37	U35000037	43	U35000043
38	U35000038	44	U35000044
39	U35000039	45	U35000045
40	U35000040	46	U35000046
41	U35000041	47	U35000047

~~€ 102,00~~

€ 59,00

443 N CHIAVE AUTOMATICA PER FILTRI OLIO

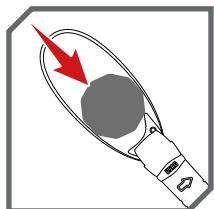

**SERRAGGIO AUTOMATICO
DEL NASTRO**

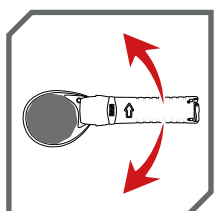

EFFETTO CRICCHETTO

Rapidità d'uso anche
in spazi ridotti.

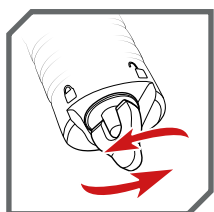

**LEVA DI INCREMENTO
POTENZA SERRAGGIO**



443 N

Cod. U04430005

66÷105 mm

**Chiave automatica a ripresa rapida
per filtri olio (autovetture)**

~~€ 90,00~~

€ 63,00



443 NC

Cod. U04430007

106÷150 mm

**Chiave automatica a ripresa rapida
per filtri olio (veicoli industriali)**

~~€ 104,00~~

€ 73,00



YouTube



65÷105 mm



443 B

Cod. U04430013

**Chiave a nastro metallico
per filtri olio (autovetture)**

~~€ 33,60~~

€ 23,50



105÷145 mm



443 BC

Cod. U04430015

**Chiave a nastro metallico per
filtri olio (veicoli industriali)**

~~€ 39,30~~

€ 27,50



60÷140 mm



444

Cod. U04440001

Chiave a nastro per filtri olio

~~€ 18,20~~

€ 12,70

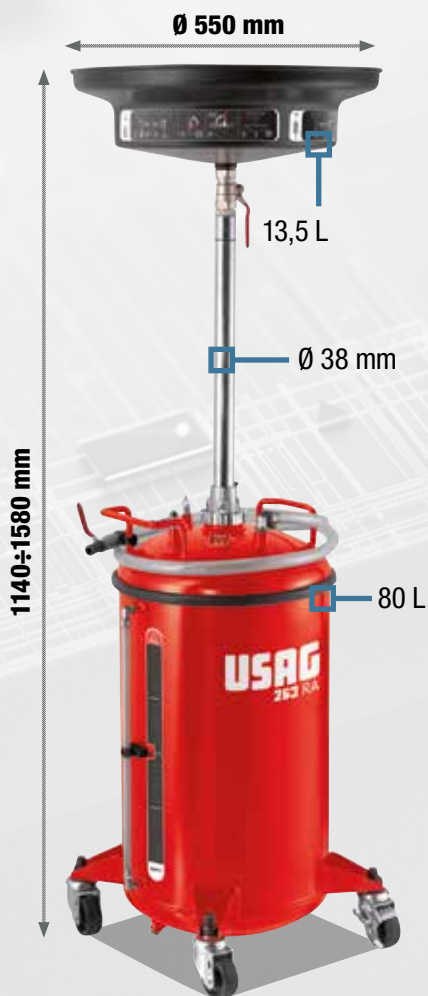

80
Litri

263 RA

Cod. U02631600

Recuperatore olio

- Modello a caduta.
- Indicatore laterale per la verifica del livello olio nel serbatoio.
- Griglia in materiale plastico all'interno della coppa.
- Sistema di svuotamento del serbatoio con aria compressa (max 3,5 bar).
- Tubo di scarico flessibile lungo 1800 mm.
- 4 ruote pivotanti: \varnothing 70 mm.

~~€ 526,00~~

€ 289,00



Compatibile con liquido freni DOT ed antigelo



Tubo esterno antiurto in poliuretano per il controllo del serbatoio



Blocco di giunzione in metallo con guarnizione interna in EPDM

Attacco per il recuperatore d'olio



16
PEZZI

263/S16

Cod. U02631400

Kit per tappi olio

- 1 chiave snodata con coppetta.
- 2 inserti \varnothing 8-10 mm.
- 6 inserti \varnothing 8-10-12-13-14-17 mm.
- 6 bussole \bullet 13-14-17-18-19-21 mm.
- 1 inserto \odot T45.



~~€ 162,00~~

€ 114,00



30
PEZZI

446 S28

Cod. U04461204

Assortimento di 30 chiavi per filtri olio

- Serie composta da 28 chiavi a tazza con quadro di manovra da 3/8", 1 adattatore da 3/8" a 1/2", 1 chiave autoserrante (capacità 65-120 mm) con quadro di manovra da 3/8".
- Il set è adatto per la maggior parte dei filtri olio montati sui veicoli circolanti.
- Misure delle 28 chiavi a tazza \varnothing x N°lati:
66/6 - 65/14 - 65/67 - 68/14 - 73/14 - 74/15 - 74/76 - 75/77 - 76/12 - 76/14 - 76/30 - 76/8 - 78/15 - 80/15 - 80/82 - 86/16 - 86/18 - 90/15 - 92/10 - 93/15 - 93/36 - 93/45 - 95/15 - 96/18 - 100/15 - 106/15 - 108/15 - 108/18.

~~€ 174,00~~

€ 122,00





POTENZA DI COMPRESSIONE

735 kg (6 bar),
1226 kg (10 bar).



447 T

Cod. U04470101

Smonta ammortizzatori pneumatico

- Ideale per autovetture.
- Sistema di autolivellamento dei bracci superiori: adatto anche a molle coniche e disassate.
- Boccole autolubrificanti: nessuna operazione di lubrificazione e/o ingrassaggio sulle colonne di scorrimento.
- Fornito con due staffe inferiori 447 TC1 (78÷130 mm) e 447 TC2 (105÷182 mm), morsa 447 TA e morsetti superiori universali 447 TB1.

CARATTERISTICHE TECNICHE

Potenza compressione	735 kg (6 bar) - 1226 kg (10 bar)
Pressione di esercizio	6÷10 bar
Corsa del pistone	420 mm
Cilindro	Doppio in lega d'alluminio e resina al nylon

~~€ 1.688,00~~

€ 1.170,00



CONFORMITÀ ALLA DIRETTIVA MACCHINE

Gli smontammortizzatori pneumatici USAG sono progettati per rispondere pienamente alla Direttiva Macchine 2006/42/CE. Alcune funzionalità della macchina sono state impostate perché l'operatore possa lavorare in totale sicurezza:

- Protezione frontale di sicurezza.
- Dispositivo di arresto del pistone in caso di apertura della protezione frontale.
- Velocità limitata: sempre inferiore ai 10 cm/sec.
- Sistema di blocco delle ganasce e del pistone in caso di interruzione dell'alimentazione dell'aria.



3500 A



BATTERIE AGM
(Absorbed Glass Mat)



12 V

1200 A

1613 AB12

Cod. U16130009

Avviatore portatile 12V

- Per avviamento di soccorso, come caricabatterie e come fonte di energia supplementare per veicoli (salvamemorie) e per apparecchi elettrici 12V.
- Scocca antiurto in ABS.
- Protezione da sovratensione.
- Idoneo anche per batterie sigillate.
- Pinze inclinate.
- Fornito con caricatore di rete e cavo per presa accendisigari.

~~€ 487,00~~

€ 340,00

LUNGHEZZA CAVI 155 cm



CE

3t

3
TON

30,5
kg

2550 A

Cod. U25500001

Sollevatore idraulico 3T per auto e veicoli commerciali

- Struttura in acciaio.
- Polivalente e compatto.
- Portata elevata per utilizzo su auto, fuoristrada e furgoni.
- Sistema a doppia pompa per sollevare più velocemente la vettura.
- Dotato di comando di discesa manuale.
- Valvola di spurgo dell'aria, per evitare il pericolo di over-carico.
- Impugnatura con gomma antiurto.
- Ruote in poliuretano.

~~€ 294,00~~

€ 199,00



CE
Pedale di avvicinamento



2t

2
TON

32,5
kg

2550 B

Cod. U25500002

Sollevatore idraulico 2T

- Struttura in acciaio.
- Per utilizzo in spazi ridotti.
- Sistema a doppia pompa per sollevare più velocemente la vettura.
- Dotato di pedale di avvicinamento.
- Dotato di comando di discesa manuale.
- Valvola di spurgo dell'aria, per evitare il pericolo di over-carico.
- Impugnatura con gomma antiurto.
- Ruote in poliuretano.

~~€ 415,00~~

€ 295,00



1950 C

Coppia colonnette

- Altezza regolabile tramite meccanismo dentato con rilascio a leva.
- Perno di bloccaggio con catena.
- 1950 C/3: modello regolabile a 10 posizioni.
- 1950 C/6: modello regolabile a 13 posizioni.

CODICE	PORTATA	PESO		
U19501001	3 t	7 kg	€ 81,50	€ 57,00
U19501002	6 t	14 kg	€ 118,00	€ 82,50



 4,1 kg |
  mm |
  230
 627
 302



9,5
Litri

1785 B

Cod. U17850005

Aspiratore liquidi manuale e pneumatico

- Per l'estrazione di oli lubrificanti da motore, freni, cambio e liquidi antigelo da qualsiasi tipo di veicolo.
- Utilizzo manuale tramite leva di pompaggio o pneumatico con ausilio dell'aria compressa.
- Serbatoio e struttura in polipropilene, per garantire un'elevata resistenza agli olii.
- Valvola di depressione situata sulla parte superiore dell'aspiratore.
- Possibilità di verificare la quantità del liquido estratto tramite indicatore laterale.
- La depressione all'interno del serbatoio diminuisce quando si raggiunge il livello massimo.

CARATTERISTICHE TECNICHE

Pressione aria raccomandata	5÷8 bar
Range temperatura liquidi aspirati	1÷100 °C
Capacità serbatoio	9,5 litri
Accessori contenuti	1 tubo principale 1500 x Ø 16 mm - 4 tubi di aspirazione: 400 x Ø 9,5 mm, 700 x Ø 6 mm, 850 x Ø 7, 700 x Ø 6

~~€ 198,00~~

€ 138,00

SPURGATORE PER CIRCUITO FRENI PRESSIONE REGOLABILE FINO A 4 BAR



2847/3

Cod. U28470084

Spurgatore per circuito freni

- Permette di cambiare, riempire, spurgare i circuiti dei freni di autoveicoli e veicoli industriali.
- Apparecchio progettato esclusivamente per liquidi freno tipo DOT 3, DOT 4, DOT 5.1. No LHM.
- Pressione regolabile fino a 4 bar.
- Arresto automatico al 10% del serbatoio (1 L).
- Alimentazione 12 V tramite cavi batteria.
- Vano posteriore accessori.
- Ruote integrate e maniglione per un facile trasporto.

CARATTERISTICHE TECNICHE

Sistema di manovra del liquido	Pompa peristaltica (nessun contatto diretto pompa liquido, nessuna pressione aria sul liquido)
Alimentazione	12 V (morsetti batteria)
Capacità serbatoio	10 litri
Limitatore di pressione	4 bar
Tubo a spirale	4 m (elastico)
Cavo di alimentazione	4 m

~~€ 1.333,00~~

€ 933,00



Fornito con:

- guarnizioni di ricambio,
- 1 tappo multidiametro 44-45-46 mm (2847 N11).
- 1 contenitore di recupero olio.

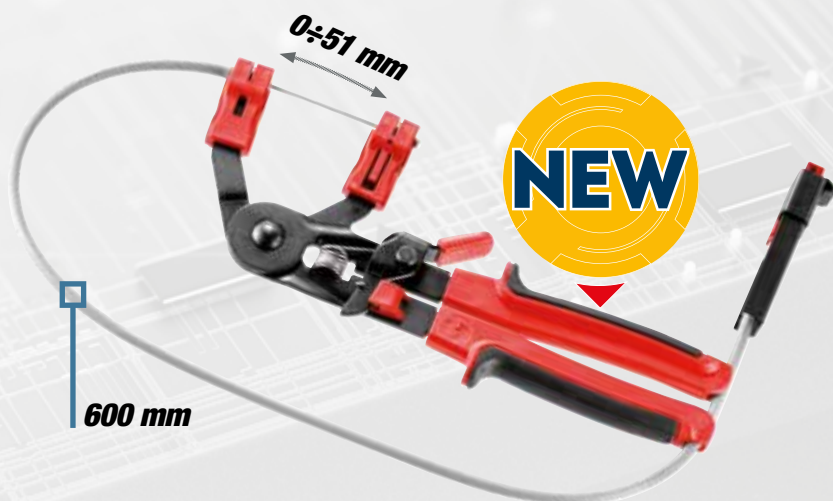

Ø
18÷54
mm

871 AN

Cod. U08710005



Pinza per anelli stringitubo

- Per tubi di raffreddamento, riscaldamento e carburazione.
- Braccio orientabile (600mm) che mantiene la posizione impostata.
- Sistema a cremagliera per ridurre gli sforzi.

~~€ 140,00~~

€ 98,00

2 in 1

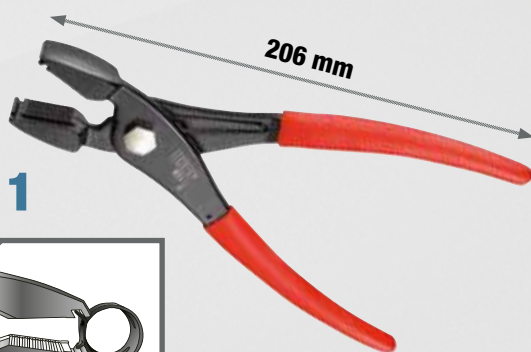
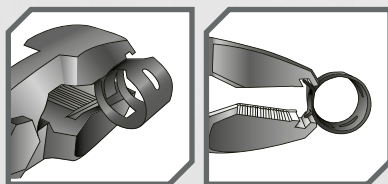

Max
20
mm

871 D

Cod. U08710001



Pinza per anelli stringitubo a presa frontale/laterale

- Possibilità di aggancio frontale o laterale.
- Ganasce con superficie di presa zigrinata.
- Molla interna di richiamo.
- Impugnature ergonomiche antiscivolo.

~~€ 46,80~~

€ 32,70



870 C

Cod. U08700006

Pinza per raccordi rapidi carburante

- Per veicoli a benzina e diesel.
- Impugnature ergonomiche bimalteriali.

~~€ 56,50~~

€ 39,60

**3 POSIZIONI
DI LAVORO**

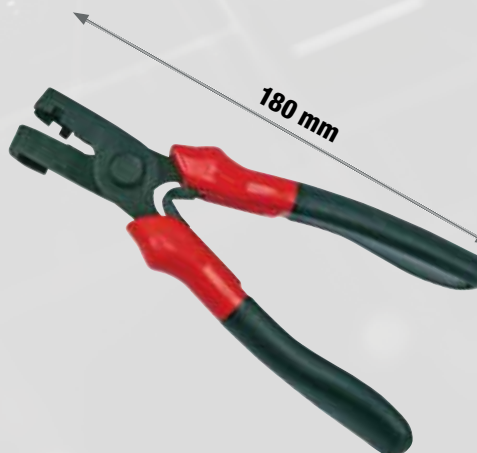

871 C

Cod. U08719005P

Pinza per fascette automatiche CLIC

- Testa triassiale per lavorare in tutte le posizioni.
- Permette di aprire o chiudere le fascette automatiche presenti sui circuiti del carburante, dei collettori d'aspirazione e dei circuiti idraulici.

~~€ 66,50~~

€ 46,60

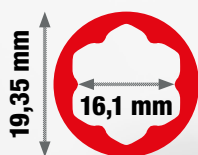

80 mm



Mercedes-Benz

1/2"

270 BM

Cod. U02700140

Chiave a bussola per dadi ruota Mercedes

- Indispensabili per allentare e serrare il nuovo profilo delle viti Mercedes.
- Protezione in téflon che riduce il rischio di danneggiamento del cerchio in lega.
- Adatta per i modelli: Classe C e GLK (W204), Classe E (W211, W212, W207), Classe SLK (W172), Classe ML (W164, W166), Classe CL (W216), Classe S (W221, W222).

~~€ 11,80~~

€ 8,30



17 19 21

3 PEZZI

270 B/C3

Cod. U02700105

Serie di 3 bussole per cerchi in lega con protezione in teflon

- 270 B/17-19-21 mm.
- Fornita in cassetta di plastica.

~~€ 96,50~~

€ 51,00



RIVESTIMENTO PROTETTIVO

Lo speciale rivestimento in teflon riduce il rischio di danneggiamento quando si opera su cerchi in lega di alluminio.



RESISTENZA SUPERIORE

L'anello in acciaio pressofuso integrato sull'estremità della bussola garantisce una resistenza 4 volte superiore alle bussole standard per dati ruote.



150 kg

2000 A

Cod. U20000100

Lettino sottoscocca 6 ruote

- Cuscino poggiatesta in vinile resistente agli idrocarburi.
- Struttura in materiale plastico resistente agli idrocarburi, lavabile.
- Due vaschette porta utensili laterali.
- Altezza massima da terra: 115mm.
- Fornito con 6 ruote in gomma pivotanti Ø 80mm (da montare).

~~€ 106,00~~

€ 72,00

KIT UNIVERSALE PER LA RIMOZIONE DI DADI E VITI ANTIFURTO



10
PEZZI

272 DS

Cod. U02720001



Kit per estrazione dadi e viti cerchi in lega

- Funziona su tutti i tipi di dadi e viti antifurto con impronte e forme diverse (standard e con anello girevole).
- Può essere utilizzato anche su dadi e viti non antifurto.
- Non danneggia il cerchio in lega.
- Punte speciali al carburo di tungsteno in grado di forare qualsiasi tipo di materiale (lubrificare con olio da taglio ad ogni utilizzo).
- Bussole coniche per centraggio/estrazione super sottili per accedere su ogni tipo di cerchio in lega.
- Estrattore con attacco esagonale testato per resistere ad oltre 150 Nm (ben oltre le coppie di serraggio dichiarate dalle case costruttrici).

~~€ 270,00~~

€ 189,00

DESCRIZIONE	ART/MISURA	PZ.
1 Punta al carburo di tungsteno	272 P Ø 8,7 mm	2
2 Bussole coniche per centraggio/estrazione	272 CS Ø19-21,8-25	3
3 Impugnatura speciale	272 PH1	1
4 Estrattori con attacco esagonale	272 EX	2
5 Bussola rimozione estrattore esagonale	272 PH2	1
6 Bussola con protezione teflon	272 B	1

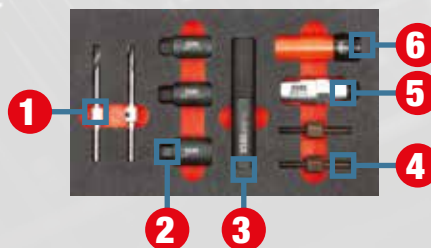

Dadi e viti antifurto standard:
svita velocemente con le bussole coniche.



Dadi e viti con anello girevole:
fora ed estrai in sicurezza con gli utensili speciali.

VIDEO
TUTORIAL



YouTube



Stanley Black & Decker Italia S.r.l.
Via Volta, 3 - 21020 Monvalle (VA)
Tel. +39 0332 790111
Fax +39 0332 790330
info.mv@usag.it

usag.it



TIMBRO DEL RIVENDITORE

Offerta valida fino al 31 gennaio 2021 salvo esaurimento scorte, presso i Rivenditori che aderiscono all'iniziativa.

Tutti i prezzi sono da intendersi in Euro, IVA esclusa. Le immagini riprodotte in questa brochure sono indicative.

Stanley Black & Decker Italia S.r.l. si riserva in ogni momento di modificare le caratteristiche tecniche dei prodotti.