



 **Beta**

**RIPARTIAMO
INSIEME**

**PROMO
NOVITÀ
2020**

Valida dal 24/08/2020 al 14/12/2020
Prezzi netti I.V.A. esclusa

C24S/7-M

024002037
€ 790,00

€ 448,00

Cassettiera mobile con 7 cassetti

- 7 cassetti da 588x367 mm, montati su guide telescopiche a sfera.
- Quattro ruote Ø 125 mm: 2 fisse e 2 girevoli (una con freno).
- Serratura di sicurezza centralizzata frontale.
- Piano dei cassetti protetto da tappetini di gomma espansa.
- Portaflacone laterale integrato.
- Possibilità di applicazione del portacarta 2400S-R/PC (da ordinare separatamente).

n°	h	max
5	70 mm	25 kg
1	140 mm	30 kg
1	210 mm	30 kg



GRIGIO ANTRACITE



Cassetto ad estrazione totale con sistema di apertura in nylon rinforzato in fibra di vetro posizionato su tutta la lunghezza del cassetto.



Piano di lavoro in ABS ad alta resistenza.

58 kg

C50S

050000301

€ 430,00

050000302

€ 248,00

Carrello di servizio con 3 cassetti

- Piano di lavoro termoplastico.
- 3 cassetti da 588x367 mm, montati su guide telescopiche a sfera, altezza 70 mm.
- Piano dei cassetti protetto da tappetini di gomma espansa.
- Serratura di sicurezza centralizzata frontale.
- Ampio ripiano inferiore protetto con tappetino in gomma antiolio e antibenzina.
- Quattro ruote Ø 125 mm: 2 fisse e 2 girevoli (una con freno).
- Portata di ogni cassetto: 15 kg uniformemente distribuiti.
- Possibilità di applicazione del portacarta 2400S-R/PC (da ordinare separatamente).
- Possibilità di applicazione della mensola pieghevole 5000MS.



INDISPENSABILE
PER LA TUA
OFFICINA!



- Pratico portagiravite laterale incluso.
- Due portabombolette laterali integrati nella struttura.

5000MS

050000901

€ 44,00

€ 25,00

Mensola pieghevole per carrello C50S

- Utilizzabile come piano di lavoro supplementare.
- Piano di lavoro mis. 390x440 mm, protetto con tappetino in gomma antiolio e antibenzina.
- Capacità di carico: 20 kg.

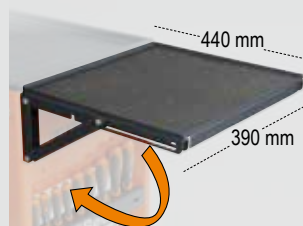

3,4 kg



n°	h	max
3	70 mm	15 kg

38 kg



5904VG/3M

059040220
€ 1.430,00

€ 810,00



Assortimento di 130 utensili
in termoformato morbido

Assortimento consigliato in abbinamento
con C23ST - C24S - C24SA - C24SA-XL -
C24SL - C24SL/CAB - C37 - C39 - C39T -
C39SM - C39MD - RSC55 - C59 - C28



N. pezzi/Descrizione

- 16 chiavi combinate 6÷21 mm
- 5 chiavi combinate 22 - 24 - 27 - 30 - 32 mm
- 1 pinza regolabili cerniera chiusa 250 mm
- 1 pinza autobloccante 240 mm
- 8 chiavi maschio esagonale con impugnatura \odot 2-2,5-3-4-5-6-7-8 mm
- 5 chiavi maschio con impugnatura per viti con impronta Torx® \odot T10-T15-T20-T25-T30
- 1 chiave regolabile a rullino 250 mm
- 1 forbici per elettricisti lame diritte
- 1 flessometro 5 m
- 1 cutter con lama a settori 170 mm
- 5 giravite lama piatta \bullet 3x75 - 3,5x100 - 4x125 - 5,5x150 - 6,5x150 mm
- 3 giravite per viti con impronta a croce Phillips® \oplus PH0x60 - PH1x80 - PH2x100 mm
- 1 giravite nano lama piatta \bullet 4x30 mm
- 1 giravite nano Phillips® \oplus PH1x30 mm
- 5 inserti colorati per avvitatori per viti a testa con intaglio \bullet 0,5x3 - 0,6x4,5 - 0,8x5,5 - 1x5,5 - 1,2x6,5 mm
- 8 inserti colorati maschio esagonale per avvitatori \odot 2 - 2,5 - 3 - 4 - 5 - 6 - 8 - 10 mm
- 5 inserti colorati per avvitatori per viti con impronta a croce Phillips® \oplus PH0 - PH1 - PH2 - PH3 - PH4
- 4 inserti colorati per avvitatori per viti con impronta a croce Pozidriv® - Supadriv® \oplus PZ1 - PZ2 - PZ3 - PZ4

Beta N.	TR
42	M15
42	M16
1048	M153
1052	M153
96T	M50
97TTX	M55
111	M292
1128BMX	M292
1692/5	M292
1771	M292
1260	M208
1262N	M208
860LP	M85
860PE	M85
860PH	M85
860PZ	M85

N. pezzi/Descrizione

- 11 inserti colorati per avvitatori per viti con impronta Torx® \odot T6-T7-T8-T9-T10-T15-T20-T25-T27-T30-T40
- 8 inserti colorati per avvitatori per viti con impronta Tamper Resistant Torx® \oplus T9-T10-T15-T20-T25-T27-T30-T40
- 1 portainseri a sgancio rapido con impugnatura 230 mm
- 1 cricchetto reversibile portainseri 100 mm
- 1 prolunga portainseri magnetica 80 mm
- 1 raccordi per avvitatori \blacksquare 1/4 - \square 1/4
- 2 scalpelli piatti nervati 100 - 200 mm
- 1 martello tipo tedesco 300 g
- 1 mazzuola con battenti in materiale plastico \varnothing 35 mm
- 1 prolunga angolare - 1/2" 125 mm
- 1 prolunga angolare - 1/2" 250 mm
- 1 snodo 1/2"
- 1 quadro maschio 1/2" con spina scorrevole
- 1 cricchetto reversibile 1/2" \oplus
- 19 chiavi a bussola esagonali 1/2" \odot 10+24 - 26 - 27 - 30 - 32 mm
- 1 tronchesi a taglienti diagonali ∇ 160 mm
- 1 pinze universali a grande effetto \equiv 180 mm
- 1 pinze a becchi mezzotondi lunghissimi \bullet 160 mm
- 1 pinze becchi dritti per anelli elastici, per fori \odot 180 mm
- 1 pinze becchi piegati per anelli elastici, per fori \odot 170 mm
- 1 pinze becchi dritti per anelli elastici, per alberi \bullet 175 mm
- 1 pinze becchi piegati per anelli elastici, per alberi \bullet 175 mm

Beta N.	TR
860TX	M85
860RTX	M85
851SR	M85
860/55	M85
882P	M85
892	M85
35	M234
1370	M234
1390	M234
920AN	M83
920AN	M83
920/25	M83
920/42	M83
920/55	M83
920A	M83
1082GBM	M134
1150GBM	M134
1166GBM	M134
1032	M145
1034	M145
1036	M145
1038	M145

16,2 kg

M133

024500133
€ 66,50

€ 38,00



- ∇ 1082G 160 mm
- \equiv 1150G 180 mm
- \bullet 1166G 160 mm



650 g

M134

024500134
€ 84,50

€ 48,50



- ∇ 1082GBM 160 mm
- \equiv 1150GBM 180 mm
- \bullet 1166GBM 160 mm



750 g

M292

024500292
€ 76,00

€ 43,50



- 111 250 mm
- 1128BMX
- 1692/5 5 m
- 1771 170 mm

500 g

C45/D

Combinazione arredo officina C45

Combinazione composta da:

- 1 modulo fisso con 7 cassetti (C45M7).
- 1 cassetiera mobile con 7 cassetti (C45C7).
- 1 modulo fisso di servizio (C45MS).
- 1 modulo fisso con 5 cassetti (C45M5).
- 1 modulo fisso con 2 antine (C45MA).
- 5 pannelli forati portautensili (C45PF).
- 5 pensili a muro (C45PM).
- 7 staffe per parete tipo largo (C45SL).
- 2 staffe per parete tipo stretto (C45SS).
- 2 armadi a 1 anta (C45AS1).

C45/DX

045000075
 € 5.970,00 **€ 3.440,00**

Combinazione arredo officina C45/DX

- 1 piano di lavoro in MDF rivestito in acciaio inossidabile (C45PX/3-2,0MT).
- 1 piano di lavoro in MDF rivestito in acciaio inossidabile (C45PX/2-1,3MT).
- 1 angolo completo autoportante con piano di lavoro in MDF rivestito in acciaio inossidabile (C45CORNER/X).



572 kg

C45/EX

045000078
 € 2.075,00 **€ 1.190,00**

Combinazione arredo officina C45/EX

Combinazione composta da:

- 2 pannelli forati portautensili (C45PF).
- 2 pensili a muro (C45PM).
- 2 staffe per parete tipo largo (C45SL).
- 1 staffa per parete tipo stretto (C45SS).
- 1 armadio a 1 anta (C45AS1).

- Modulo fisso con 7 cassetti e piano di lavoro in MDF rivestito in acciaio inossidabile (C45M7A/X):
 - 1 cassetto da 1248x406 mm;
 - 6 cassetti da 782x406 mm
5 x h 85 mm, 1 x h 155 mm;
 - 1 vano portaoggetti con ripiano intermedio e antina di chiusura.

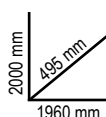
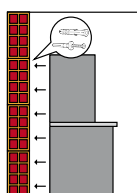

174 kg

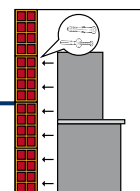

C45/DW

045000076 € 3.370,00
~~€ 5.850,00~~

Combinazione arredo officina C45/DW

- 1 piano di lavoro in legno multistrato (C45PW/3-2,0MT).
- 1 piano di lavoro in legno multistrato (C45PW/2-1,3MT).
- 1 angolo completo autoportante con piano di lavoro in legno (C45CORNER/W).

568 kg

C45/EW

045000079 € 1.130,00
~~€ 1.975,00~~

Combinazione arredo officina C45/EW

Combinazione composta da:

- 2 pannelli forati portautensili (C45PF)
- 2 pensili a muro (C45PM)
- 2 staffe per parete tipo largo (C45SL)
- 1 staffa per parete tipo stretto (C45SS)
- 1 armadio a 1 anta (C45AS1)

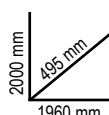
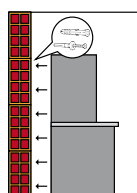

- Modulo fisso con 7 cassetti e piano di lavoro in legno multistrato (C45M7A/W):
 - 1 cassetto da 1248x406 mm;
 - 6 cassetti da 782x406 mm 5 x h 85 mm, 1 x h 155 mm;
 - 1 vano portaoggetti con ripiano intermedio e antina di chiusura.

173 kg

C56PL O

056000021
€ 299,00

€ 170,00

Banco da lavoro pieghevole, versione Light

- Leggero, compatto e facilmente trasportabile.
- Maniglia con protezione in gomma per un agevole trasporto.
- Piedini con copertura anti-scivolamento.
- Capacità di carico statico: 200 kg.

• Piano di lavoro 800x500 mm in lamiera zincata utilizzabile da un solo lato, protetto con rivestimento in gomma antiolio e antibenzina.

**ANCORA PIÙ LEGGERO!
SOLO 18,5 kg**



18,5 kg

4900-COVER C49

049000930
€ 25,50

€ 14,50

Protezione in nylon per carrello multifunzione C49

- Materiale: Nylon.
- Dimensioni: 562 x 1002 x 592 mm.





900/55Z

009000882

€ 22,50

~~€ 39,00~~

Cricchetto reversibile con attacco quadro maschio 1/4", cromato

• Meccanismo a 72 denti.

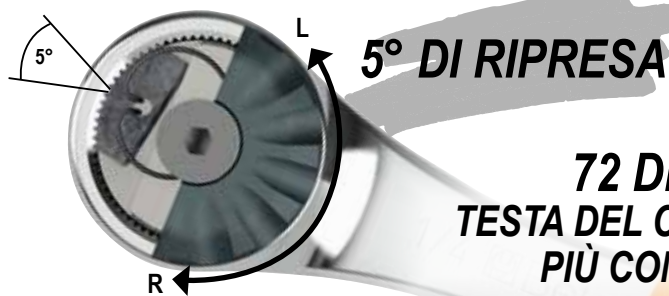

72 DENTI
TESTA DEL CRICCHETTO
PIÙ COMPATTA

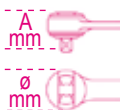

L mm	Ø mm	A mm	■
126	25	23	1/4

90 g

900/C12MZ

009000983

€ 106,00

~~€ 187,50~~

Assortimento di 12 chiavi a bussola esagonali, 20 inserti per avvitatori e 7 accessori in termoformato morbido, in cassetta di lamiera

	861LP	●	0,5-0,8-1-1,2 mm
	861PE	○	3-4-5-6-8 mm
	861PH	⊕	PH0-PH1-PH2-PH3
	861TX	⊗	T8-T10-T15-T20-T25-T30-T40
	895/1	○	1/4" - □1/4"
	900	○	4-5-5,5-6-7-8-9-10-11-12-13-14 mm
	900/20		50 mm
	900/21		150 mm
	900/25		
	900/42		115 mm
	900BG/30		128 mm
	900/55Z	⊗	



350x150x50 mm

1,2 kg



910FTX/XL-C10

009100976

€ 94,00

~~€ 163,00~~

Assortimento di 10 chiavi a bussola per viti con impronta Torx® tipo lungo, in cassetta di plastica

⊗ E6-E7-E8-E10-E11
E12-E14-E16-E18-E20



BUSSOLE LUNGHE
200 mm



255x195x62 mm

1 kg

1169G/D3

011690073

~~€ 56,50~~

€ 32,50

Assortimento di 1 pinza universale,
1 pinza becchi mezzotondi lunghi
e 1 tronchese,
con 2 strati di PVC antiscivolo
con *finitura industriale*



Il PERNO DECENTRATO
avvicina il fulcro al punto
di taglio, aumentando
l'effetto leva.

NUOVA FINITURA



1082G 160 mm



1166G 160 mm



1150G 180 mm

700 g

1169GBM/D3

011690273

~~€ 71,50~~

€ 41,00

Assortimento di 1 pinza universale,
1 pinza becchi mezzotondi lunghi
e 1 tronchese,
impugnatura bimateriale,
con *finitura industriale*



Il PERNO DECENTRATO
avvicina il fulcro al punto
di taglio, aumentando
l'effetto leva.

NUOVA FINITURA



1082GBM 160 mm



1166GBM 160 mm



1150GBM 180 mm

760 g



**Torcia LED per ispezioni,
in robusto alluminio anodizzato**

- Cono luminoso regolabile.

NUOVO DESIGN



1833 XS/1

018330000
~~€ 16,50~~

€ 9,50



- Durata 5.0 h
- L 92 mm

33 g

1833 XS/2

018330001
~~€ 18,00~~

€ 10,40



- Durata 10.0 h
- L 133 mm

53 g

**Torcia LED ad alta luminosità
in robusto alluminio anodizzato**

- Cono luminoso regolabile.
- 2 intensità luminose.

NUOVO DESIGN



1833 S

018330002
~~€ 31,50~~

€ 18,20



- Durata 10.0 h
- L 150 mm

62 g

1833 L

018330004
~~€ 64,50~~

€ 37,50



- Durata 8.5 h
- L 196 mm

300 g

1833 M

018330003
~~€ 39,00~~

€ 22,50

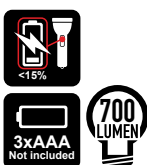

- Durata 7.5 h
- L 162 mm

165 g

1833 XL

018330005
~~€ 81,00~~

€ 47,00

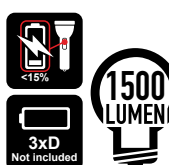

- Durata 22.0 h
- L 300 mm

420 g

1833 L/USB

018330054
~~€ 95,00~~

€ 55,00

**Torcia LED ricaricabile ad alta luminosità
in robusto alluminio anodizzato,
fino a 1200 Lumen**

- Cono luminoso regolabile.
- 3 intensità luminose.
- Durata 3.0 h.
- Ricarica con attacco USB-C.
- Caricatore non incluso.

NUOVO DESIGN

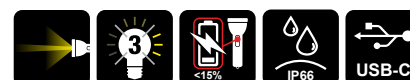

L 240 mm

RICARICABILE

380 g

1837F

018370050
~~€ 70,00~~

€ 40,50

Lampada magnetica snodata con LED ad alta luminosità, in robusto alluminio anodizzato, fino a 500 Lumen

- Cono luminoso regolabile.
- 2 intensità luminose.
- Pile 3xAA (non incluse).
- Durata 14.5 h.
- Indicatore di carica.

NUOVO DESIGN



L 460 mm

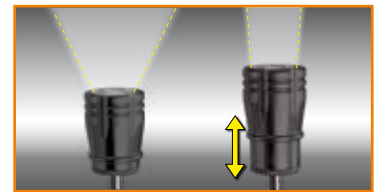
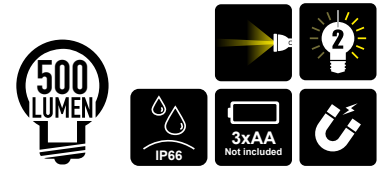

300 g

1837F/USB

018370060
~~€ 103,00~~

€ 59,50

Lampada ricaricabile magnetica snodata con LED ad alta luminosità, in robusto alluminio anodizzato, fino a 600 Lumen

- Cono luminoso regolabile.
- 2 intensità luminose.
- Durata 10.0 h.
- Ricarica con attacco USB-C.

RICARICABILE

NUOVO DESIGN



L 460 mm

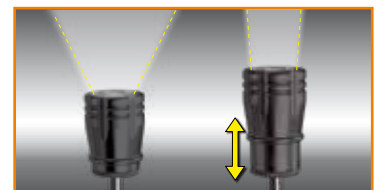
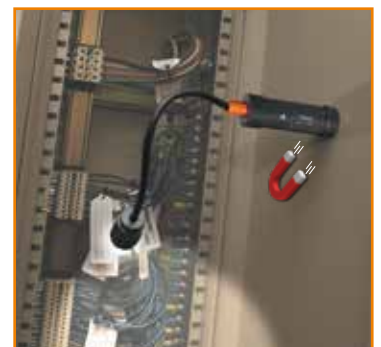
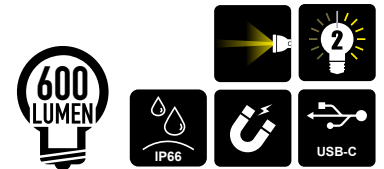

325 g



1838S

018380122
~~€ 71,00~~

€ 41,00

Lampada snodata ricaricabile a LED

- Orientabile a 180°.
- Corpo in gomma antiscivolo.
- Doppio gancio orientabile.
- Magneti su base e retro.
- Fornita con caricatore 100-240V / 50-60Hz.
- Tempo di ricarica: 4h.
- Autonomia: 2-7.5 h.

2 EMISSIONI LUMINOSE

- FRONTALE: 150/300/700 lumen
- SPOT (TESTA): 200 lumen



260x52x38 mm

RICARICABILE



380 g

1838SLIM

018380221
~~€ 60,00~~

€ 34,50

Lampada sottile a 3 LED snodata ricaricabile

- Base magnetica.
- Tempo di ricarica: 2.5 h.
- Autonomia: 2-4 h/ spot 3 h.

3 EMISSIONI LUMINOSE

- FRONTALE: 100/200 lumen
- POSTERIORE: 180 lumen
- SPOT (TESTA): 80 lumen



307x29x17 mm

RICARICABILE

80 g

1693

016930020

€ 102,00

€ 58,50

IP54 CE

**Misuratore di distanza laser
20 metri**

MISURAZIONI:

- Misura di distanza singola.
- Misura continua o misurazione minima.
- Auto spegnimento.
- Durata batteria: fino a 4.000 misurazioni.

20 METRI

DATI TECNICI

Campo di misurazione	da 0,05 a 20m (da 0.2in a 66f)
Selezione scala	m, in, ft
Precisione	±1,5 mm (± 0.06 in)
Classe Laser	2
Batterie	AAA 2 x 1.5V

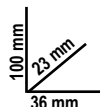

80 g

1693M

016930080

€ 172,00

€ 98,50

IP54 CE

**Misuratore di distanza laser,
multifunzione, 80 metri**

MISURAZIONI:

- Misura di distanza singola.
- Misura continua o misurazione minima.

FUNZIONI:

- Addizione/sottrazione.
- Misura dell'area.
- Misura del volume.
- Misurazione indiretta variabile (misurazione pitagorica).
- Misurazione inclinazione.
- Auto spegnimento.
- Custodia morbida in tela (inclusa).
- Durata batteria: fino a 4.000 misurazioni.

80 METRI

DATI TECNICI

Campo di misurazione	da 0,05 a 80m (da 0.2in a 229f)
Selezione scala	m, in, ft
Precisione	±1,5 mm (± 0.06 in)
Classe Laser	2
Memorizzazione misure	99
Batterie	AAA 2 x 1.5V



110 g



7043

070430001
~~€ 92,00~~

€ 52,50



Maschera LCD ad oscuramento automatico,
 per saldatura ad elettrodo, MIG/MAG,
 TIG e plasma. Alimentazione a celle solari.

- Area di visuale 92x43 mm.
- Tonalità di oscuramento DIN 9-13 con regolazione esterna.
- Protezione UV/IR.
- Tempo d'oscuramento 1/1000 s.
- Tempo di rischiaramento 0.1-1.0 s.
- Ritardo dell'oscuramento regolabile.
- Accensione e spegnimento automatici.
- Funzione di smerigliatura.
- Forma ottimizzata per agevolare la respirazione a schermo abbassato.



900 g

1144L

011440050
~~€ 25,00~~

€ 14,50

Spellacavi con lama regolabile
 per tagli trasversali e longitudinali,
 con lama retrattile liscia ed a uncino



Ø 4 ÷ 28 mm



70 g

1148P

011480300
~~€ 38,00~~

€ 22,00

Pinza spellafili autoregolabile
 con dispositivo di taglio

0,2 ÷ 6,0 mm²



5 - 12 mm

Ø max. 2 mm
 CU/AL

0,2 - 6,0 mm²

105 g

1600Q 8

016000008

€ 13,90

~~€ 24,00~~

Chiave a croce per quadristi

Chiave utilizzabile per la manutenzione in numerosi settori come quello elettrico, idraulico, ventilazione, gas e altro.



75 g

1600Q 10

016000010

€ 17,90

~~€ 31,00~~

Chiave snodabile a doppia croce per quadristi

- Doppia croce ruotante per selezionare comodamente l'impronta da utilizzare.
- Giunto snodabile magnetico per esercitare maggiore forza.
- Attacco quadro maschio da 1/4" per l'utilizzo di chiavi a bussola manuali.
- Chiave utilizzabile per la manutenzione in numerosi settori come quello elettrico, idraulico, ventilazione, gas e altro.



105 g

9738

Olio da taglio

- Ad alto potere lubrificante e protettivo.
- Indicato per fresatura, alesatura, filettatura, foratura e lavorazioni per macchine manuali e automatiche.
- Elevata resistenza all'ossidazione.
- Lavabile con acqua.
- Non contiene solventi.



097380040	€ 6,00	€ 3,40
097381040	N.D.	N.D.

400 ml

9741

Detergente, sgrassante multiuso

- Detergente e sgrassante per sciogliere grasso, olio, catrame, silicone e colla.
- Adatto per pulizia di superfici in metallo, plastica rigida, ceramica, acciaio e alluminio.
- Non lascia residui oleosi.



097410040	€ 5,90	€ 3,35
097411040	N.D.	N.D.

400 ml

1996MQ/T

019960005 **€ 44,50**
~~€ 77,00~~

Telo isolante
500x500 mm

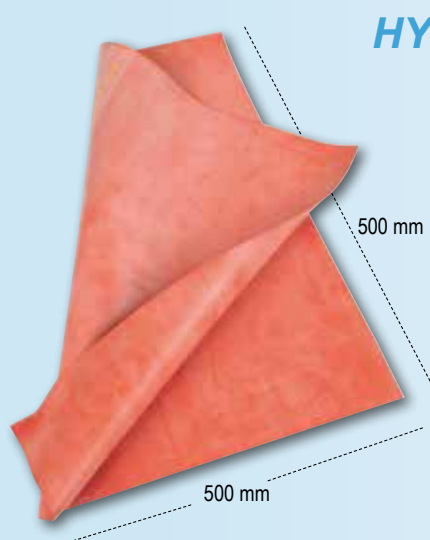

HYBRID 

 370 g

1996MQ/GM

Guanti isolanti composti

CE

HYBRID 



Gr	L mm		€ 130,00	€ 75,00
9	410	019960109	€ 130,00	€ 75,00
10	410	019960110	€ 130,00	€ 75,00

 442 g

1996SVG

019960133 **€ 172,00**
~~€ 298,00~~

Strumento per la verifica pneumatica dei guanti isolati

• Obbligatoria per la EN90603.



HYBRID 

 500 g

1898/K40

018980004

€ 3.780,00

€ 2.180,00

CE

Vasca manuale per la pulizia di pezzi meccanici a ricircolo con liquido riscaldato e batteri

- Permette l'eliminazione dei costi di smaltimento per solventi o idrocarburi.
- Utilizzando il detergente ecologico Beta a base di enzimi e batteri permette la rimozione e lo smaltimento dei vari residui oleosi presenti sui pezzi meccanici.
- La funzione enzimatica aiuta a scindere la parte oleosa dalla parte solida di sporco mentre i batteri trasformano la stessa in anidride carbonica e acqua rigenerando costantemente il detergente.



**NESSUN
SMALTIMENTO
DI LIQUIDI!**

**EFFICACE
ED ECOLOGICA**

DOTATA DI:

- Spazzola a setole lunghe e tubazione di collegamento
- Predisposizione per utilizzo destrorso e sinistrorso.
- Griglia forata in acciaio inox.
- Ruote con freno.
- Scheda con display per visualizzazione temperatura di funzionamento ed avviso livello troppo basso.

INCLUDE:

- N° 2 taniche di liquido detergente ecocompatibile da 20 litri e n° 2 confezioni di batteri.



1000 mm
750 mm
900 mm



DATI TECNICI

Portata massima pompa	10 litri/minuto
Capacità serbatoio	40 litri
Temperatura di funzionamento	+5°C ÷ +40°C
Peso	50 kg a vuoto

ATTENZIONE:

Paesi in cui è possibile distribuire il prodotto 1898/K40 sono: Austria, Belgio, Francia (da inizio 2021), Italia, Paesi Bassi, Polonia, Portogallo, Regno Unito, Spagna, Ungheria.



50 kg



1760DGT/2

017600008

€ 620,00

€ 358,00



Multimetro digitale automotive portatile con oscilloscopio a 2 canali e generatore d'onda

IL KIT INCLUDE:

- Puntali multimetro
- 2 connettori coccodrillo BNC per oscilloscopio
- Sonda a puntale per oscilloscopio (1X e 10X)
- Caricabatteria
- Custodia in nylon



199 mm
40 mm
98 mm

INCLUDE OSCILLOSCOPIO A 2 CANALI!



DATI TECNICI	
Display	TFT a colori da 2,8"
Risoluzione	320 x 240 pixels
Alimentazione	100V-240V AC, 50Hz-60Hz; DC INPUT 5V DC-2A
Batteria	2 x 2600 mAh
Peso	624 g

SPECIFICHE MULTIMETRO

Test: Tensione, Corrente, Resistenza, Capacità, Diodi e On-Off
 Tensione Max: 600V DC
 Corrente Max: 10A DC
 Resistenza Max: 40MOHM
 Capacità Max: 100uF

SPECIFICHE OSCILLOSCOPIO

Orizzontale
 Larghezza banda: 40MHz
 Intervallo di frequenza campionamento: 250MSa/s (singolo canale) - 125MSa/s (doppio canale)
 Gamma SEC/DIV: 5ns/div ÷ 500s/div 1,2,5 sequence

Verticale
 Gamma VOLTS/DIV: 10mV/div÷10V/divat ingresso BNC
 Analogico selezionabile limite larghezza di banda, tipico: 20MHz
 Risposta a bassa frequenza (-3db): ≤10Hz a BNC
 DC Gain Accuracy: ± 3% per la modalità di acquisizione Normale o Media, da 10V/div a 10 mV/div

Trigger
 Type: Edge
 Mode: Auto, Normal, Single
 Slope: Rising, Falling, Rising, & Falling
 Source: CH1, CH2

Ingresso
 Accoppiamento: DC, AC o GND
 Fattori di attenuazione della sonda supportati: 1X, 10X, 100X, 1000X

Generatore di forma d'onda arbitraria
 Frequenza forma d'onda: Sine (1Hz÷25MHz), Square (1Hz÷10MHz), Ramp (1Hz÷MHz), EXP (1Hz÷5MHz)
 Ampiezza: 2,5Vpp (50Ω) - 5Vpp (alta impedenza)
 Impedenza di uscita: 50Ω



624 g

1497KB/S3

014970050

~~€ 69,00~~

€ 40,00

Kit di 3 utensili per rimozione connettori elettrici Knorr e Bremse

- 1 utensile per connettori a baionetta.
- 1 utensile con impronta per connettori a 2 poli.
- 1 utensile con doppia impronta per connettori a 4 o 6 poli e 12 poli.



437 g

1497/S3

014970400

~~€ 15,50~~

€ 8,90

Serie di 3 cavetti per rilevazioni segnali elettrici

- 1 pz dritto
- 1 pz 45°
- 1 pz 90°



1760DGT 017600005



10 g

1760TMC

017600710

~~€ 695,00~~

€ 399,00

IP54 CE

Termocamera ad infrarossi

Termocamera compatta per la misurazione della temperatura senza contatto, adatta per applicazioni nei settori edile, meccanica ed impianti elettrici e di riscaldamento.

- Temperatura da $-20 \div +600^{\circ}\text{C}$.
- Display LCD TFT da 2 pollici 240x320.
- Sensore da 32x32 pixel.
- Frequenza di acquisizione 7Hz.
- Termosensibilità $<347\text{mK}$.
- Acquisizione automatica dei punti caldi e freddi.
- Fotocamera di acquisizione immagini in formato BMP (massimo 100 immagini).
- Emissività regolabile.
- Alimentazione 3 batterie alkaline AAA.
- Interfaccia USB.
- IP54
- Banda infrarossi $6.5 \div 14\mu\text{m}$.
- Distanza di fusione visibile/infrarosso 0.5; 1; 2 m.
- Funzione allarme, selezionando la temperatura massima e minima accettabili.



**TEMPERATURA
DA $-20 \div +600^{\circ}\text{C}$**

450 g



1878 2

018780002

€ 12,00

€ 6,90

Vaschetta per recupero liquidi

- Capacità massima 2 l.
- Particolarmente indicata per la sostituzione olio sugli scooter.



2 Litri

l	H mm
2	85

280 g

1878 4

018780004

€ 25,00

€ 14,50

Vaschetta per recupero liquidi trasportabile

- Indicata per moto.
- Capacità massima 4 l.
- Limita gli schizzi.



4 Litri

l	H mm
4	100

500 g

1878 8

018780008

€ 13,50

€ 7,80

Vaschetta per recupero liquidi

- Altezza idonea per moto.
- Capacità massima 8 l.



8 Litri

l	H mm
8	110

500 g

1879/FUEL

018790010

€ 110,00

€ 63,50

Aspiratore liquidi manuale da 6 litri

Utilizzabile per idrocarburi



550±710 mm
235 mm
235 mm



**RESISTENTE
AGLI
IDROCARBURI**

1,3 kg

960T/C11

009600031
~~€ 162,00~~

€ 93,50

38" 12"

Assortimento bussole per rimozione/installazione sensori

Incluse nel kit:

- 1 bussola esagonale doppia misura 1" - 11/16" per sensori di pressione olio
- 1 bussola esagonale aperta 29 mm per sensori ossigeno
- 1 bussola poligonale aperta 27 mm per iniettori
- 1 bussola esagonale aperta 22 mm per vacuostato
- 1 bussola esagonale aperta 22 mm lunga 80 mm per sensori ossigeno
- 1 bussola esagonale aperta 22 mm lunga 90 mm per sensori ossigeno
- 1 bussola esagonale aperta 22 mm compatta lunga 30 mm per sensori ossigeno
- 1 bussola esagonale aperta 22 mm compatta lunga 50 mm per sensori ossigeno
- 1 bussola aperta 22 mm compatta lunga 34 mm ad impronta esagonale e poligonale, per sensori ossigeno
- 1 bussola esagonale aperta 22 mm con geometria a tubo
- 1 maschio M18x1,5



330x270x25 mm

3,1 kg

1456/C8

014560010
~~€ 62,50~~

€ 36,00

Kit per allineamento guarnizione della testa

Consente un rapido e preciso posizionamento della guarnizione della testa

Inclusi nel kit:

- 1 coppia di perni guida M10x1,5 lunghezza 60 mm
- 1 coppia di perni guida M10x1,5 lunghezza 35 mm
- 1 coppia di perni guida M9x1,25 lunghezza 55 mm
- 1 impugnatura per rimozione perni guida
- 1 prolunga per rimozione perni guida



300x90x65 mm

650 g

1462CF-SN/C6

014620026
~~€ 115,00~~

€ 66,00

38"

Serie di 6 chiavi snodate esagonali aperte per raccordi carburante iniettori

Misure: 12-14-16-17-18-19



275x182x64 mm

1,6 kg



1438DCT

014380300
€ 125,00

€ 72,00

38"

**Attrezzo per smontaggio, montaggio
frizione cambio DCT a 6 rapporti**

Utilizzabile su Volvo, Ford, Chrysler, Dodge



1,2 kg

1474E/VW2

014740150
€ 29,00

€ 16,50

**Estrattore bobine accensione
gruppo VAG**

Utilizzabile su motori 1.0 - 1.2 - 1.4 - 2.0



200 g

1758B-RNT

017580035
€ 21,50

€ 12,50

**Attacco rapido antiriflusso
per imbuto 1758B**

Per motore Renault 1.5 dCi

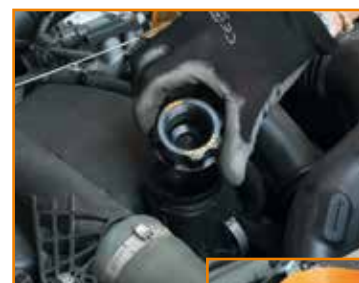

1758B
017580030



20 g

1484PSA

014840012

~~€ 13,50~~

€ 7,80

Attrezzo per il montaggio delle cinghia elastica della pompa dell'acqua senza tendicinghia

Utilizzabile per gruppo PSA e Opel motori 1.0 - 1.2



10 g

1485MRC/T

014850315

~~€ 27,00~~

€ 15,60

Leva per il tensionamento delle cinghie dei servizi, montate su motori Mercedes

Utilizzabile per motori M133 - M270

L 510 mm



L mm	⊗
510	T55

465 g

1485VLV/T

014850320

~~€ 55,50~~

€ 32,00

Leva per il tensionamento delle cinghie dei servizi, montate su motori Volvo

L 420 mm



L mm	⊗	○ mm
420	T50-T60	15

460 g



1481K/S4

014810400

€ 25,00

€ 14,50

Kit di 4 morsetti autoserranti per occlusione linee

Misure: 5/16" - 3/8" - 1/2" e passante

5/16" - 3/8" - 1/2" e passante



90 g

1482/2

014820002

€ 98,00

€ 56,50

Chiave regolabile autoserrante per ghiere galleggianti serbatoio



Ø mm	⊘ mm
89÷200	16

1,6 kg

1529/PG

015290010

€ 55,50

€ 32,00

Estrattore per pompa alta pressione gasolio vetture gruppo VAG



⊘ mm	
15-24	

555 g



1467TU

014670090
~~€ 56,00~~

€ 32,00

Tappo per vaschette liquido freni

- Adattabile al 90% delle vaschette del parco circolante.
- Utilizzabile con articolo Beta 1467LF.

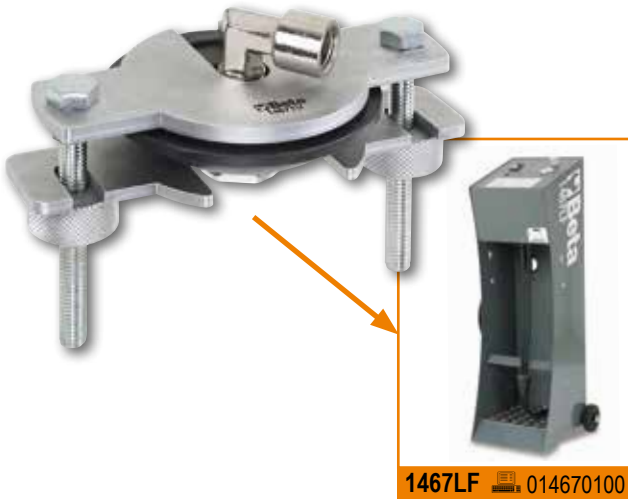

1467LF 014670100

600 g

1470PF

014700200
~~€ 64,00~~

€ 37,00



Attrezzo per la sostituzione dei cilindri nei freni a tamburo

Le ganasce restano divaricate, ed il cilindro viene facilmente sostituito

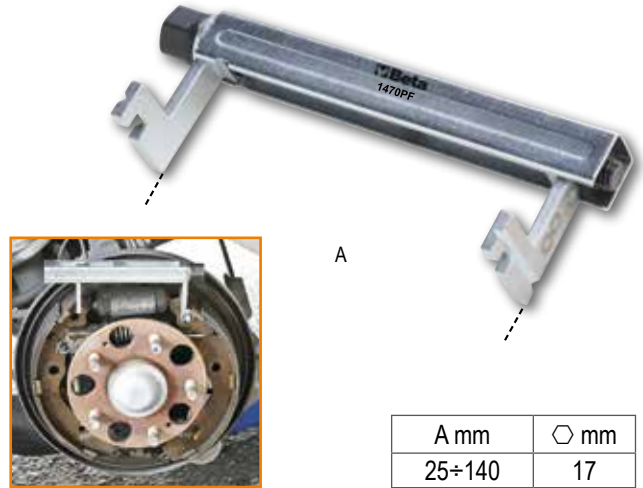

A mm	⊕ mm
25÷140	17

250 g

1471GF

014710310
~~€ 12,00~~

€ 6,90

Coppia di ganci modellabili per il sostegno della pinza freno durante la sostituzione delle pastiglie



Max 5 kg

50 g

1528

015280000
~~€ 147,00~~

€ 85,00



Estrattore autoserrante per dischi freno

A min÷Max mm	⊕ mm
170÷380	19



480x240x60 mm

4,8 kg



728L/S3

007280393

~~€ 119,00~~

€ 69,00

Serie di 3 chiavi a bussola Macchina

© 30-32-36 mm



3/4"



2,2 kg

437K/9

004370029

~~€ 70,00~~

€ 40,00

Assortimento per ripristino filettature maschio e femmina, viti fissaggio ruote

• Permette di ripassare e rinvivare il filetto originale.

Inclusi nel kit:

- maschi:
M12x1,25 - M12x1,5 - M12x1,75 - M14x1,5
- filiere:
M12x1,25 - M12x1,5 - M14x1,5



mm

12 - 24

161x123x50 mm

550 g

437K/10

004370030

~~€ 105,00~~

€ 60,00

Assortimento per il ripristino delle filettature danneggiate dei sensori ossigeno M18x1,5

Inclusi nel kit:

- 1 alesatore pilota M18
- 1 maschio M18x1,5
- 1 maschio M20x1,5
- 5 boccole filettate M18x1,5
- 1 utensile di manovra per boccole



mm

13 - 27

190x105x40 mm

800 g

437K/12

004370032

~~€ 84,00~~

€ 48,00

Assortimento per ripristino filetti semiassi

• Permette di ripassare e rinvivare il filetto originale.

Incluse nel kit:

- Misure metriche:
M16x1,0 - M16x1,5 - M20x1,0 - M20x1,5 -
M22x1,5 - M24x1,5 - M24x2,0 - M27x2,0
- Misure in pollici:
3/4x16 - 3/4x20 - 13/16x20 - 27/32x20



mm

32 - 35

220x118x52 mm

840 g

3070BE/K

030700250
€ 2.630,00

€ 1.498,00



Equilibratrice elettronica portatile a lancio manuale

Sistema di equilibratura con microprocessore a lancio manuale (senza motore) che permette l'equilibratura di ruote in ferro o in lega di auto e moto.

- Compatta e facilmente trasportabile può essere utilizzata in officina, all'interno di furgoni o nei box dei circuiti.
- Può essere fissata su un banco o su una parete.
- Il software include tutti i programmi di correzione dello squilibrio con indicazione delle posizioni con pesi adesivi (ALUS), pesi nascosti dietro le razze (SPLIT) e ottimizzazione dello squilibrio.
- Può essere utilizzata con supporto orientabile BETA 3070BE/S (optional).



**COMPATTA
E PORTATILE**

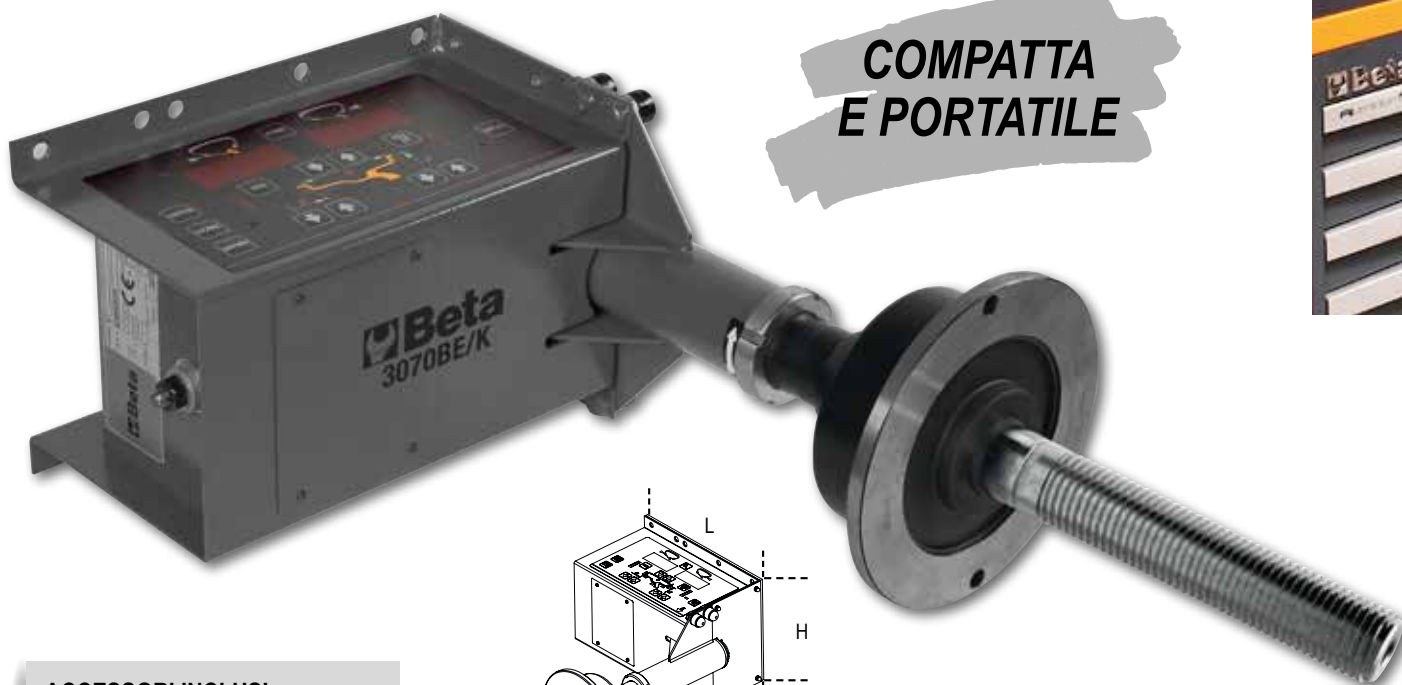

ACCESSORI INCLUSI

- Righello flessibile graduato.
- Ghiera di serraggio con volantino e 3 coni da $\varnothing 45 \div 110$ mm.

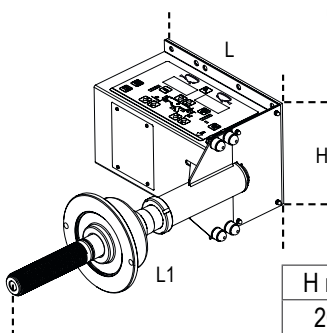

H mm	L mm	L1 mm
200	381,5	646



DATI TECNICI	
Alimentazione	115-230V AC o 12-24V DC
Potenza massima assorbita	0.15 kW
Velocità di equilibratura	100 rpm
Incertezza di misura	1 gr
Larghezza cerchione impostabile	1.5" ÷ 20" (40 ÷ 510 mm)
Peso massimo della ruota	max 75 kg



14,5 kg



3070BE/F

030700202

€ 1.320,00

€ 758,00

Flangia universale motocicli Ø 40 mm per 3070BE/K

Utilizzabile sulle ruote con foro centrale passante con Ø da 15 a 35 mm e sulle ruote flangiate con centratura fino a Ø 68 mm.



4,5 kg

3070BE/S

030700201

€ 970,00

€ 558,00

Supporto orientabile per equilibratrice elettronica 3070BE/K

Permette il fissaggio a parete o a banco dell'equilibratrice riducendo gli ingombri e gli spazi di installazione.



10,8 kg

3070BE/B

030700203

€ 1.475,00

€ 848,00

Kit di 8 coppie di bussole per il centraggio delle ruote dei motocicli per 3070BE/K

Permette di operare sui seguenti Ø:
28 - 25 - 22 - 20 - 19,05 - 17 - 16 - 15



1,2 kg

1551/C20

015510020

~~€ 130,00~~

€ 75,00

Kit per smontaggio teste ammortizzatori

Inclusi nel kit:

- 7 bussole esagonali misure: 16 - 17 - 18 - 19 - 21 - 22 - 24
- 1 prolunga porta bussola lunga 120 mm
- 3 inserti femmina con cava misure: 8x5 - 8x6 - 11x8
- 1 inserto femmina esagonale misura: 10 mm
- 1 inserto maschio XZN® misura: M10
- 1 inserto maschio Torx® misura: T50
- 4 inserti maschio esagonali misure: 5- 6 - 7 - 8
- 1 prolunga porta inserti lunga 95 mm
- 1 prolunga porta inserti lunga 190 mm



12"



5/16"

320x245x71 mm

2,6 kg

1552/C9

015520020

~~€ 103,00~~

€ 59,50

Kit per divaricare i giunti di ammortizzatori, bracci oscillanti e sterzo

È possibile lavorare con testa a singolo o doppio divaricatore, in modo da poter operare anche sui giunti doppi tipo gruppo VAG



mm

13

195x140x40 mm

1 kg

1558/C13

015580200

~~€ 184,00~~

€ 105,00

Attrezzo per anelli seeger interni ed esterni con azionamento a vite

Grazie all'attacco quadro si applica una forza elevata in entrambe le condizioni d'utilizzo

Puntali in dotazione:

- dritti: Ø 2,5 - 3 - 3,5 - 3,8 mm
- 45°: Ø 2,5 - 3 - 3,5 - 3,8 mm
- 90°: Ø 2,5 - 3 - 3,5 - 3,8 mm



3/8"

Ø mm

Ø mm

5,5÷77

5,5÷77

330x220x45 mm

1,8 kg



Kit di 4 protezioni in nylon per ruote

- Conserva e protegge la ruota da eventuali graffi e polvere.
- Durante lo stoccaggio, previene il precoce deterioramento dei polimeri della gomma del pneumatico estivo o invernale.
- Dotate di impugnatura per un comodo trasporto.
- Tessuto: nylon, lavabile.

4x

**IDEALE PER
LO STOCCAGGIO
DELLE RUOTE**



Attraverso un'icona identificativa, permette la facile individuazione della posizione ruota (anteriore destra/sinistra o posteriore destra/sinistra)

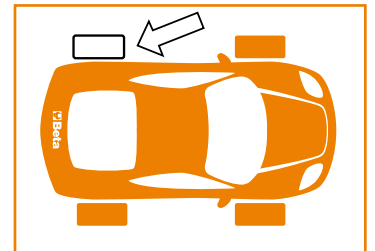

973 14-18

009730014

€ 85,00

€ 49,00

Idoneo per cerchi da:

14" a 18" codice 009730014

19" a 22" codice 009730019

973 19-22

009730019

€ 94,00

€ 54,00

1367/K10

013670200

€ 150,00

€ 86,50

Kit di fustelle per installazione sensori di parcheggio

Incluse nel kit:

- Misure: 17 - 18 - 18,2 - 19 - 20 - 22,5 - 24 - 26 - 26,7 - 32 mm

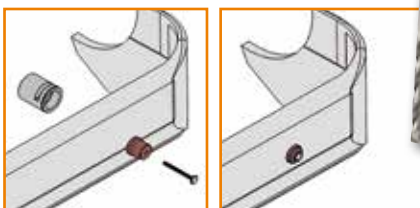

**FORI
PERPENDICOLARI
SENZA BAVE**



◻ mm
12

190x130x58 mm

645 g

1360G

013600000

€ 62,00

€ 35,50

Martello in gomma morbida antirimbalo, per montaggio guarnizioni e componenti delicati

L'estrema morbidezza del battente permette di non danneggiare le parti lavorate, in quanto assorbe l'urto deformandosi

L mm	Ø mm
280	72



ESTREMA MORBIDEZZA DEL BATTENTE

670 g

1479LB/C5

014790150

€ 89,00

€ 51,50

Kit di 5 levapioli in metallo



215x165x50 mm

770 g

1479LV/S3

014790100

€ 25,00

€ 14,50

Kit di 3 leverini multifunzione in metallo

Misure:

1479LV/1: 10x12 mm

1479LV/2: 4,8x9,6 mm

1479LV/3: 2,8x6 mm



114 g

1479ML/B17

014790700

€ 54,00

€ 31,00

Kit di 17 leverini multifunzione in materiale plastico



PARTICOLARMENTE ADATTI PER LAVORI DI PRECISIONE

130x205x30 mm

250 g



3003PRO

030030150
€ 280,00

€ 162,00

Letto sottomacchina in materiale plastico antiurto

Dotato di:

- Cuscino poggiatesta ergonomico.
- Protezione morbida per la schiena.
- 2 ruote da 178 mm con doppio cuscinetto che permettono l'utilizzo anche su superfici sconnesse e il superamento di tubi/cavi.
- 1 ruota girevole.
- Doppia regolazione dell'altezza da terra: 38 o 76 mm.
- 2 lampade a led portatili da 250 lumen con magneti per fissaggio.
- Capacità di carico: 200 kg.
- Peso: 7,7 kg.

**RESISTENTE ED
ERGONOMICO**

Max kg
200



DOPPIA LAMPADA A LED CON FISSAGGIO MAGNETICO



H min mm	H Max mm	L mm	L1 mm
170	230	1040	570

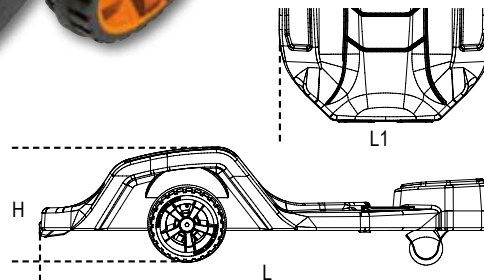

7,7 kg



3003PRO/SP

030030151
€ 75,00

€ 43,00



Supporto in plastica da parete per letto 3003PRO

Può essere applicato su una parete, ponte, cassettiera o altro permettendo il fissaggio del letto attraverso un sistema rapido e veloce con chiusura di sicurezza.



3003PRO/PM

030030152
€ 8,00

€ 4,50



Portaminuterie magnetico tondo per letto 3003PRO

Applicandolo sul cerchio delle ruote del letto permette il trattenimento delle minuterie durante gli interventi.



3003C

030030100

€ 199,00

€ 115,00

Letino sottomacchina in plastica antiurto

Dotato di:

- Cuscino per la testa e per la zona lombare con finitura in carbon look.
- Piastrine superiori in metallo. per il fissaggio di accessori magnetici
- 6 ruote in gomma con diametro 79 mm.



Max kg
120



5,5 kg

2254SM

022540033

€ 56,00

€ 32,00

Tappeto sottomacchina in EVA

Doppia finitura:

- 1 lato in morbido EVA.
- 1 lato in carbon look rigido per favorire lo scivolamento.



1050 mm height, 33 mm thickness, 460 mm width



670 g

3026/SA

030260510

€ 119,00

€ 68,50

Supporto mozzo ruota per sollevatori da fossa

- Utilizzabile per interventi di manutenzione inerenti ai mozzi, e durante le operazioni di sostituzione degli ammortizzatori.
- Adattabile ai sollevatori idraulici da fossa 3026 0,3 e 3026 0,5.



3026 0,3 - 3026 0,5



950 g

3026/SAM

030260515

€ 154,00

€ 89,00

Supporto ammortizzatori per sollevatori da fossa

- Utilizzabile per sostenere l'ammortizzatore quando si smonta il braccio della sospensione.
- Staffa per ammortizzatori con diametro Max 80 mm, più riduzione per diametri Max 60 mm.
- Adattabile ai sollevatori idraulici da fossa 3026 0,3 e 3026 0,5.



2,5 kg

8181 6/S4

4x

081810906
~~€ 83,00~~

€ 34,50

Kit 4 sistemi di ancoraggio LC 1000kg, con zainetto in poliestere impermeabile

Terminali con ganci a uncino
Larghezza nastro: 35mm
Lunghezza totale: 6 m



EN 12195-2

L m	L1 mm	L2 mm
6	400	5600

4 kg

8182 8,5/S2

2x

081821985
~~€ 78,00~~

€ 32,00

Kit 2 sistemi di ancoraggio LC 2000kg, con zainetto in poliestere impermeabile

Terminali con ganci a uncino
Larghezza nastro: 50mm
Lunghezza totale: 8,5 m



EN 12195-2

L m	L1 mm	L2 mm
8,5	400	8100

5,5 kg

8190 10

081900010
~~€ 76,00~~

€ 36,00

Tendicatena di ancoraggio a cricchetto con due ganci per 8190B 8-10 mm Grado 8

- DATI TECNICI**
- coefficiente di sicurezza: 2
 - trattamento termico: ganci bonificati
 - codice lotto
- CERTIFICATI DISPONIBILI**
- Specifica Prodotto
 - Rapporto di Prova tipo 2.2 UNI EN10204
 - Certificato di Controllo tipo 3.1 UNI EN10204

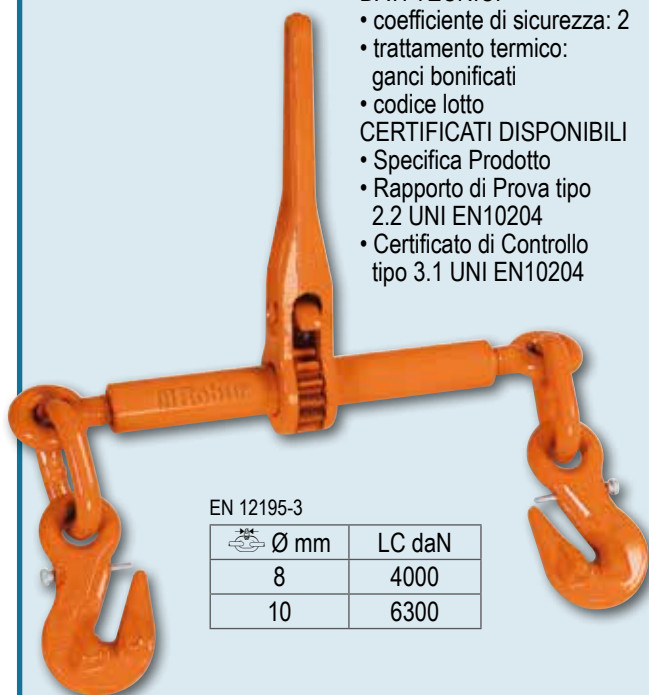

EN 12195-3

Ø mm	LC daN
8	4000
10	6300

5,5 kg

8190B 8X3,5

081901308
~~€ 166,00~~

€ 70,00

Ø mm	LC daN	L m	kg
8	4000	3,5	6

8190B 10X3,5

081901310
~~€ 232,00~~

€ 97,00

Ø mm	LC daN	L m	kg
10	6300	3,5	9,8

Brache di ancoraggio carichi per tendicatena a cricchetto Grado 8

- DATI TECNICI**
- coefficiente di sicurezza: 2
 - trattamento termico: bonifica
 - piastrina di identificazione seriale
- CERTIFICATI ALLEGATI**
- Certificato del Fabbrikante
- CERTIFICATI DISPONIBILI**
- Rapporto di Prova tipo 2.2 UNI EN10204
 - Specifica Prodotto

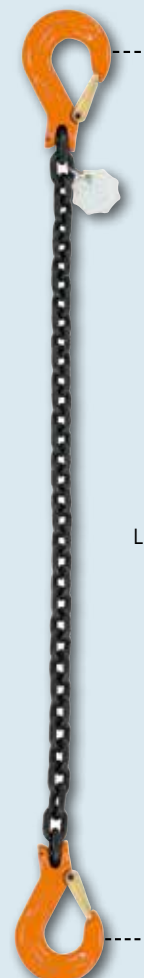

7362B

~~€ 94,00~~

€ 53,50

Scarpe "occupational" in tessuto mesh ad alta traspirazione con inserti in TPU.

Supporto di stabilità tallone, collare "slip on" elasticizzato per facilitare la calzatura e suola in EVA con battistrada in gomma nitrilica ad alta resistenza

- Senza puntale.
- Senza lamina antiperforazione.



0-GRAVITY



EU	UK	
39	6	073620039
40	6,5	073620040
41	7	073620041
42	8	073620042
43	9	073620043
44	10	073620044
45	10,5	073620045
46	11	073620046
47	12	073620047
48	13	073620048

EN 20347
2012

01 FO HRO SRC

LEGGEREZZA STRAORDINARIA:
peso indicativo misura 42:
330 GRAMMI

7363N

~~€ 98,00~~

€ 56,50

Scarpe "occupational" in tessuto mesh idrorepellente con inserti in TPU

Supporto di stabilità tallone, collare "slip on" elasticizzato per facilitare la calzatura e suola in EVA con battistrada in gomma nitrilica ad alta resistenza

- Senza puntale.
- Senza lamina antiperforazione.



0-GRAVITY



EU	UK	
39	6	073630039
40	6,5	073630040
41	7	073630041
42	8	073630042
43	9	073630043
44	10	073630044
45	10,5	073630045
46	11	073630046
47	12	073630047
48	13	073630048

EN 20347
2012

02 FO HRO SRC

7431P

~~€ 6,90~~

€ 3,90

Due paia di calzini sneaker con inserti in texture traspirante

Un paio di colore nero/arancio e un paio di colore nero/grigio

- Resistenti.
- Traspiranti.
- Rinforzi in nylon e cotone su pianta e tallone.
- Prodotte con fibra naturale di bamboo.



CONFEZIONE
DA 2 PAIA

M	L	
39-42		074310102
43-46		074310104

Bamboo fiber



breathable

resistant

anti bacterial



7528 *Jeans*

~~€ 49,50~~

€ 28,50

**Jeans da lavoro elasticizzati
in 98% cotone e 2% tessuto elasticizzato**

- Prelavaggio "stone washed".
- Due ampie tasche anteriori.
- Due tasche posteriori.
- Tascone laterale sinistro con chiusura a strappo e taschino porta minuteria.
- Tasca porta metro e fascia porta martello.



SLIM FIT



XS	075280046
S	075280048
M	075280050
L	075280052
XL	075280054
XXL	075280056
XXXL	075280058

7529 *Jeans*

~~€ 39,50~~

€ 22,90

**Bermuda jeans da lavoro elasticizzati
in 98% cotone e 2% tessuto elasticizzato**

- Prelavaggio "stone washed".
- Due ampie tasche anteriori.
- Due tasche posteriori.
- Tascone laterale sinistro con chiusura a strappo e taschino porta minuteria.
- Tasca porta metro e fascia porta martello.



SLIM FIT



XS	075290046
S	075290048
M	075290050
L	075290052
XL	075290054
XXL	075290056
XXXL	075290058

7575N

~~€ 70,00~~

€ 39,90

**Gilet softshell
in 90 nylon, 10% tessuto
elasticizzato, 250 g**

- Chiusura frontale con zip.
- Due tasche in vita con chiusura zip.
- Tasca esterna al petto con chiusura zip verticale.



S	075750301
M	075750302
L	075750303
XL	075750304
XXL	075750305
XXXL	075750306

7547BL

~~€ 23,00~~

€ 13,50

Polo 3 bottoni
in 100% cotone 200 g,
blu

XS	075470200
S	075470201
M	075470202
L	075470203
XL	075470204
XXL	075470205
XXXL	075470206



7547G

~~€ 23,00~~

€ 13,50

Polo 3 bottoni
in 100% cotone 200 g,
grigia

XS	075470300
S	075470301
M	075470302
L	075470303
XL	075470304
XXL	075470305
XXXL	075470306



7547N

~~€ 23,00~~

€ 13,50

Polo 3 bottoni
in 100% cotone 200 g,
nera

XS	075470400
S	075470401
M	075470402
L	075470403
XL	075470404
XXL	075470405
XXXL	075470406





7549BL

~~€ 15,00~~

€ 8,90

T-shirt work in 100% cotone
150 g, blu

XS	075490200
S	075490201
M	075490202
L	075490203
XL	075490204
XXL	075490205
XXXL	075490206



7549G

~~€ 15,00~~

€ 8,90

T-shirt work in 100% cotone
150 g, grigia

XS	075490300
S	075490301
M	075490302
L	075490303
XL	075490304
XXL	075490305
XXXL	075490306



7549N

~~€ 15,00~~

€ 8,90

T-shirt work in 100% cotone
150 g, nera

XS	075490400
S	075490401
M	075490402
L	075490403
XL	075490404
XXL	075490405
XXXL	075490406



9565T

095650200
€ 390,00

€ 209,00

Tavolo in lamiera d'acciaio con piano in legno multistrato di betulla verniciato

Fornito con doppio KIT di tubi distanziali (7 o 20 cm) per regolare l'altezza a piacere.

*Piano regolabile
in altezza
7 o 20 cm*

h 95 → 108 cm - Ø 70 cm



18,2 kg

9565S

095650300
€ 170,00

€ 95,00

Seduta in lamiera d'acciaio con sedile in ecopelle sfoderabile



h 60 cm - Ø 38 cm

6 kg

9565K

095650500
€ 730,00

€ 399,00

Tavolo 9565T con due sedute 9565S



30,2 kg



9565BBQ

095650100
€ 460,00

€ 246,00



Barbecue in lamiera d'acciaio con griglia e braciere

- Dotato di coperchio con morsetto per la chiusura.
- Griglia in acciaio cromato (conforme alla normativa italiana DM 21.03.73 e regolamento CE 1935/2004 in riferimento all'idoneità del materiale a contatto con gli alimenti), dotata di maniglie e piedini d'appoggio.



h 88 cm - Ø 59 cm

22 kg

9565ICE

095650400
€ 180,00

€ 99,00

Portagiaccio in lamiera d'acciaio



- Dotato di coperchio di chiusura, con contenitore antigraffio, certificato per uso alimentare.
- L'interno del fusto è laccato con vernice antiruggine e resistente.
- Nel contenitore si possono collocare ghiaccio e bottiglie/lattine da raffreddare.

h 60 cm - Ø 38 cm

6 kg

998015671



Beta Utensili S.p.A.
Via Volta 18
20845 Sovico (MB)
Tel. 039.2077.1
Fax 039.2010742
www.beta-tools.com

Promozione valida dal 24/08/2020 al 14/12/2020.
Prezzi netti I.V.A. esclusa



Le immagini sono indicative, Beta si riserva il diritto di apportare aggiornamenti e migliorie alla propria gamma produttiva senza alcun preavviso.